

SEKONIC

LITEMASTER PRO
L-478D/L-478DR

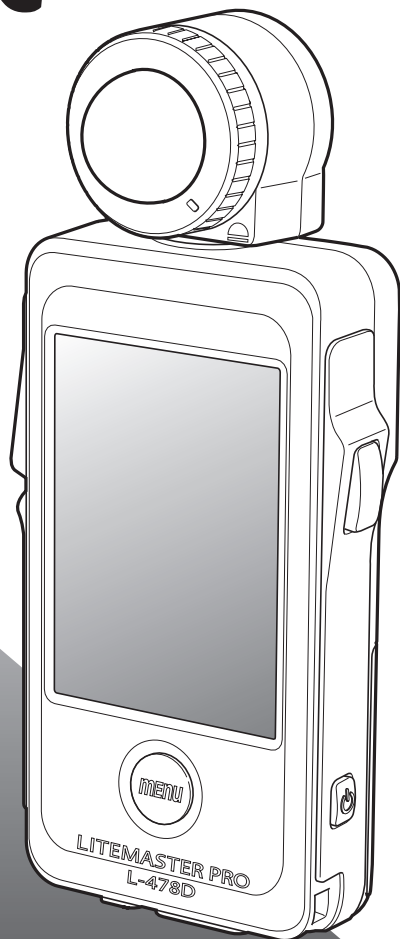

Operating Manual

Thank you for purchasing LITEMASTER PRO L-478D/L-478DR.
Please read this Users' Manual thoroughly in order to become acquainted with the light meter and thus be able to use it safely and correctly.

The LITEMASTER PRO L-478D/L-478DR (referred to as L-478D/L-478DR from here on) comes with "Camera exposure profile" to offer today's digital and film shooter with repeatable precision, accurate measurement and digital exposure control.. What is more, L-478D/L-478DR are equipped with exceptional functions to deal with images and all sorts of shooting/filming intentions whether you are a DSLR videographer, cinematographer, still photographer or involved in any faced of image capture.

Using the latest Data Transfer Software*1, you can set your camera exposure profiles*2 in the L-478D/L-478DR (up to ten camera profiles). And, by calling up these settings when you need them, you can measure exposure accurately. Moreover, when metering light, you can check in an instant whether or not the subject is in the exposure range. Additionally, you can also make User Setting and Custom Setting Function in the Data Transfer Software.

*1 Data Transfer Software is an application software provided on the CD-ROM or downloaded from www.sekonic.com. To use this software, you will need to install it onto your computer and connect it to L-478D/L-478DR via a USB cable. Please see the Operating Manual on the CD-ROM for details of operation.

*2 Exposure profile is the information denoting the characteristics of your digital cameras and matching the light meter's value to the unique variations in the camera, lens shutter speed, aperture, etc. First, authenticate the information by test shooting and then create exposure profiles using the Data Transfer Software.

! Note

1. The reproduction of all or any part of this document without permission is strictly forbidden.
2. The product concerned and/or this manual may be subject to future changes without prior notification.

Accompanying Accessories

The following items are included with the L-478D/L-478DR. After opening the package, please be sure that everything is included. If any of the following items should be missing, please contact your local camera store or retail organization.

Start-up Guide

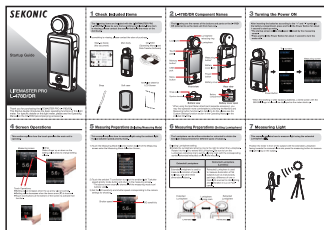

CD-ROM
(Operating Manual and Data Transfer Software)



Soft case

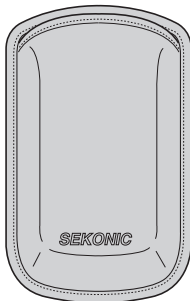

Strap







Anti-glare film



• Please see "7. Separately Sold Accessories" (P65) for details about available accessories.

Safety Precautions

Before using this product, please read this “Safety Precautions” for proper operation.

 Warning	The warning symbol indicates the possibility of death or serious injury if the product is not used properly.
 Caution	The caution symbol indicates the possibility of minor to moderate personal injury or product damage if the product is not used properly.
 Note	The note symbol indicates cautions or restrictions when using the product. Please read all notes to avoid errors in operation.
 Reference	The reference symbol indicates additional information about the controls or related functions. Reading these is recommended.

Warning

- Infants or toddlers may accidentally wrap the strap around their neck, so please place it in a location out of their reach. There is a danger of suffocation.
- Do not place batteries in open flame, attempt to short them, disassemble them, apply heat to them, or recharge them (except rechargeable batteries). They may burst and cause fire, serious injury, or damage to the environment.
- Do not look directly at the sun via the viewfinder (sold separately), as doing so may damage eyesight.
- For L-478DR only: If user intentionally modifies or converts the L-478DR, there is a **risk that doing so may violate the Radio Law**, which may make the user liable to punishment according to the law.

Caution

- Do not handle this product with wet hands, or leave it in the rain or in a location where it may be splashed with water or come into contact with moisture. There is a danger of electric shock if the “Cord Flash Mode” is used. This may also result in damage to the product.
- Do not disassemble this product for modification or parts replacement. Refer servicing only to qualified and authorized personnel in case of product’s malfunction.
- Do not play the accompanying CD-ROM in a music-type CD player, as there is a risk of hearing damage as well as damage to speakers and/or earphones.
- Use fingers to lightly touch the LCD when operating. Do not use sharp objects such as ballpoint pens or pencils, as doing so may damage the LCD or cause malfunction.

Note

The LCD is covered by a protective sheet. Please peel off this sheet before using the screen.

Table of Contents

■ Accompanying Accessories	3
■ Safety Precautions	4
1 Parts Designations	8
1-1. Parts Designations.....	8
2 Before Using	9
2-1. Attaching the Strap.....	9
2-2. Inserting the Batteries.....	9
2-3. Power ON/OFF	10
2-4. Checking the Battery Capacity.....	11
2-5. Cautions about Changing the Batteries during Measurement.....	11
2-6. Auto Power OFF Function	11
3 Screen Operations	12
3-1. On-screen Operations	12
3-2. Locking and Releasing of Screen	14
3-3. Outline of Screen Flowchart	14
3-4. Measuring Screen.....	16
3-4-1. Status/Title Field	16
3-4-2. Setting, Function, Display Field	17
3-4-3. Measuring Function Selection Icon	19
3-5. Information Screen	20
3-6. Tool Box Screen.....	20
3-7. Menu Screen.....	21
4 Basic Operations	22
4-1. Basic Operation Flow	22
4-2. Setting Light Receiving System.....	23
4-2-1. Measuring with Incident Light Function (Lumisphere Extended /Retracted)	23
4-2-2. Measuring with Reflected Light System	24
4-3. Setting Measuring Mode	25
5 Measuring	27
5-1. Measuring in Ambient Light Mode.....	27
5-1-1. T (Shutter Speed) Priority Mode	27
5-1-2. F (f-stop) Priority Mode	28
5-1-3. TF Priority Mode	28
5-1-4. Illuminance/Luminance Mode.....	28
5-1-5. Measuring Exposure for Video and Movies	31

Table of Contents

5-2. Measuring in Flash Light Mode	33
5-2-1. Cord (PC) Flash Mode.....	34
5-2-2. Cordless Flash Mode	35
5-2-3. Cord Multi (Cumulative) Flash Mode.....	36
5-2-4. Cordless Multiple (Cumulative) Flash Mode	37
5-3. Measuring with Radio-controlled Flash (for L-478DR only)	38
5-3-1. How to Measure Using Radio Control	38
5-3-2. How to Measure with Radio Control Channels.....	38
5-3-3. Using the Power Control Settings.....	40
5-3-4. Measuring in Radio Flash Mode	41
5-3-5. Measuring in Radio Triggering Multiple (Cumulative) Flash Mode.....	42
5-4. Out of Displayed Range or Measuring Range	42
5-4-1. When Displayed Range is Exceeded.....	42
5-4-2. When Measuring Range is Exceeded.....	42
6 Functions.....	43
6-1. Memory Function.....	43
6-1-1. Memory	43
6-1-2. Memory Recall	44
6-1-3. Memory Clear.....	45
6-2. Mid. Tone Function	46
6-2-1. Setting Measuring Value as Mid. Tone.....	46
6-2-2. Setting Memorized Value as Mid. Tone.....	46
6-2-3. Mid. Tone Modification.....	47
6-2-4. Mid. Tone Clearing	47
6-2-5. Mid. Tone Recall	48
6-3. Average Function.....	49
6-4. Contrast Function	50
6-5. Filter Compensation Function	51
6-5-1. Setting Filter Numbers and Compensation Values	51
6-5-2. Selecting Filter Factor Number	52
6-5-3. Deselecting Filter	52
6-6. Functions by Menu Selection	53
6-6-1. Analog Scale Switching	53
6-6-2. Exposure Compensation Function	53
6-6-3. Custom Setting Function	55
6-6-4. Exposure Profile Function	56
6-6-5. Frame Rate Editing	58
6-6-6. Shutter Angle Editing	59

6-6-7. Filter Name Editing.....	60
6-7. Hardware Setting Function.....	62
7 Optional Accessories (Sold Separately).....	65
8 Registered Filters	66
9 Specifications	67
10 Safety Guide and Maintenance	69

1 Parts Designations

1-1. Parts Designations

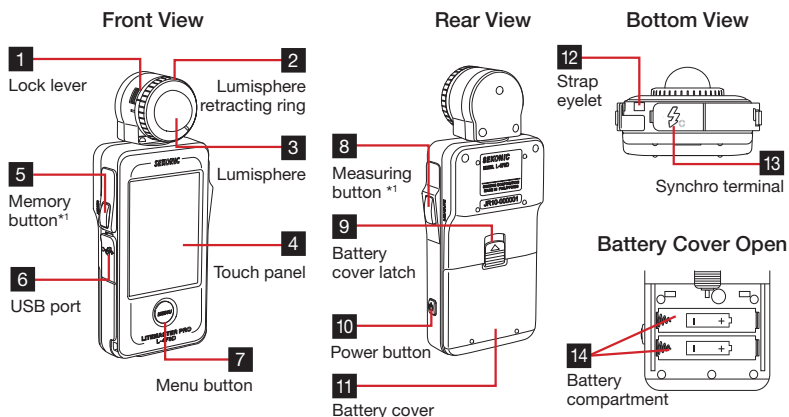

The following table lists the functions of each part.

No.	Part Name	Explanation
1	Lock lever	Slide back when removing the lumisphere from the meter. (See P24 for details.)
2	Lumispher retracting ring	Turn to switch between extended and retracted lumisphere. (See P23 for details.)
3	Lumispher	Extend to measure exposure. Retract to measure contrast. Can be freely rotated through 270° to receive light.
4	Touch panel	Displays measuring screens and setting screens. Touch this panel to perform settings and operations. (See P12 for details.)
5	Memory button*1	Press to memorize current measured value. Press in multi (cumulative) mode to clear memorized measurements.
6	USB port	Accepts USB Mini B cable for connection to computer for use with Data Transfer Software.
7	Menu button	Press to enter Menu mode from any of the screens. Press again to return to the previous screen. (See P21 for details.)
8	Measuring button*1	Press when the Measuring screen is displayed to implement measuring.
9	Battery cover latch	Slide up to open battery cover.
10	Power button	Use to turn power ON and OFF. Hold down (approximately one second) when turning power ON and OFF.
11	Battery cover	Lift up to reveal 2x AAA batteries that power the meter.
12	Strap eyelet	Attach accessory strap here.
13	Synchro terminal	Plug in synchro cord (sold separate) connected to separate flash here when using Cord (PC) Mode.
14	Battery compartment	Holds 2x AAA size batteries. Insert as indicated in compartment.

*1 Using Custom Setting Function, the Memory button 5 and the Measuring button 8 can be switched (See P55 for details.)

2 Before Using

2-1. Attaching the Strap

- 1) Pass the strap included through the outer hole of the Strap eyelet **12**.
- 2) Pass the opposite end of the strap through the loop at the end of strap.

Warning

Infants or toddlers may accidentally wrap the strap around their neck, so please place it in a location out of their reach. There is a danger of suffocation.

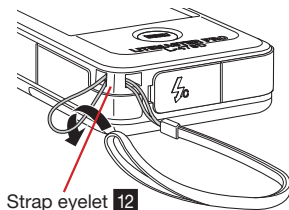

2-2. Inserting the Batteries

- 1) Requires two AAA alkaline manganese batteries.
- 2) Slide the Battery cover latch **9** in the direction of the arrow and remove the Battery cover **11**.
- 3) Insert the batteries according to the “+” and “-” symbols in the Battery compartment **14**.
* As shown in the diagram to the right, please note both positive sides of the batteries are facing in the same direction.
- 4) While lining up the two tabs on the Battery cover **11**, press the Battery cover **11** back into place from above.

Warning

Do not place batteries in open flame, attempt to short them, disassemble them, apply heat to them, or recharge them (except rechargeable batteries). They may burst and cause fires, serious injury, or damage to the environment.

Caution

- Insert the batteries minus (-) side first. When removing batteries, pull out plus (+) side first.
- Do not use batteries with any other rating than the one specified. Also, do not mix old and new batteries.
- If the meter will not be used for an extended period of time, it is recommended to remove the batteries to avoid possible damage caused by battery leaking.

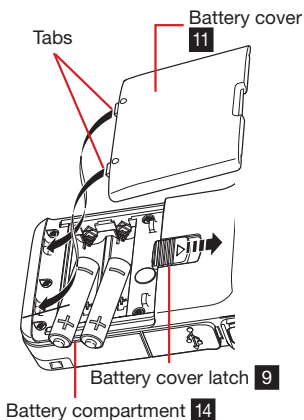

2-3. Power ON/OFF

Power ON: Press the Power button **10** for one second.

The meter will turn on, and after the title screen is displayed, the Measuring screen appears.

Power OFF: Press and hold the Power button **10** for one second or longer. The meter will turn off and the display disappears.

Title Screens

L-478D

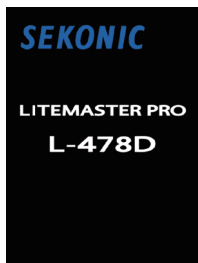

L-478DR



Power button **10**

! Note

- Please wait 3 seconds between repeated power on and power off sessions.
- Directly after replacing the batteries, a white screen with the SEKONIC logo in blue will be displayed, followed by the appropriate title screen above.
- An L-478D/DR memory check is being executed while the blue bar graph is moving when the Logo screen is displayed, so please do not turn OFF the power, as doing so may cause damage.

Logo Screen





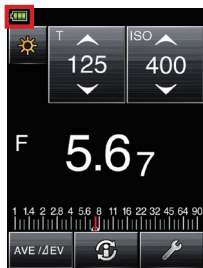

Reference

- If the LCD screen shows no display, check the battery capacity indicator. Also check for proper battery insertion (Pos/Neg positioning).
- All settings and measurements made during use are saved in memory even after the meter is powered off.

2-4. Checking the Battery Capacity



When the power is turned on, the battery power indicator is displayed at the upper left of the LCD.

-  Full battery power remaining.
-  Sufficient battery power remaining.
-  Low battery power remaining. Have spare batteries ready.
-  When the indicator blinks, replace batteries immediately.

Reference

- When the batteries are out of power and the meter is turned ON, the LCD screen will appear and then turn off immediately. This is an indication that the batteries are depleted and they should be replaced immediately. Having spare batteries on hand is recommended.
- When the meter is continuously used at room temperature, the battery life with alkaline batteries will last 10 hours (based on our testing).

2-5. Cautions about Changing the Batteries during Measurement

- 1) Always turn off the power before replacing batteries.
- 2) If an unexpected display appears on the LCD during battery replacement or measurement, ie. settings other than selected, or if the meter does not respond when a button is pressed, remove the batteries, wait at least 10 seconds, and then re-install them.

2-6. Auto Power OFF Function

To save battery power, the meter will automatically turn off five minutes after the last button is pressed.

Reference

- All settings and measurements are saved in memory even after the meter has automatically turned off. When the power is turned ON, they will be displayed again.
- Default Auto Power OFF is 5 minutes. Select longer time in Custom Setting. (See P55 for details).
- To prevent battery drain during transport, the meter will switch OFF after approximately one minute if the Power Button **10** is held down continuously.

3 Screen Operations

The data display is also a touch panel that is used to make all settings

<Display illumination>

- The Display illumination is activated as soon as the meter is turned ON. The illumination level is user adjustable. The panel dims during measuring and cordless flash standby to eliminate its influence in the measurement.
- The display illumination of your meter has been set to "Bright" at the factory to enable best operation for outdoor use. For indoor viewing and better battery life, you may set the screen illumination to "Normal" in Custom Setting. Please see P55 for details

3-1. On-screen Operations

Touch the icons on screen to perform various operations.

The following are the icon types.

1) Measuring Mode Icon

Touch the Measuring mode icon to display the Measuring Mode Selection screen. Touch any icon to switch to the desired Measuring mode. (See P25 for details.)

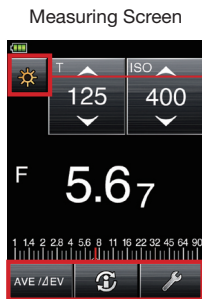

Measuring Mode Selection Screen



2) Setting Value Change/Item Selection Icon

Touch Operation:

Touch the up arrow (▲) to increase the value or change up to the next item.

Touch the down arrow (▼) to decrease the value or change down to the next item.

Slide Operation:

Slide your finger tip up or down over the value to change the value amount.

Sliding your finger over scroll bars provides fast navigation of large menus.



Edit Frame Rate Screen

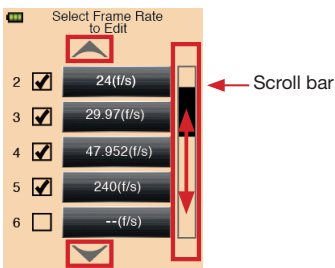

3) Radio Buttons

Touching Radio buttons selects the item to the right of it.

Only one item in a group can be selected at one time.

Filter Compensation Setting Screen

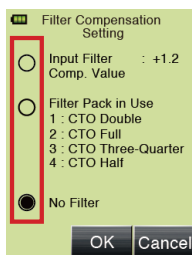

4) Alpha-Numeric Keypad

Value Input Screen



Alphabet Input Screen



Number Input Screen



Inputting Values (Value Input Screen):

0-9, Decimal point, +/-:

Value displayed on screen when key touched.

OK:

Confirms input value and returns to previous screen.

DEL:

Deletes input value.

Cancel:

Cancels input and returns to previous screen.

Inputting Alphabet and Numbers (Alphabet Input Screen and Number Input Screen):

1/A/a:

Switches between Ten Key input/Uppercase/Lowercase.

ABC(abc), 0-9, Decimal Point:

Value displayed on screen when key touched.

Repeated pressing of the same button for alphabet

(ABC/abc) will change the alphabet character in order.

← →:

Shift input position.

OK:

Confirms input value and returns to previous screen.

DEL:

Deletes input value.

Cancel:

Cancels inputting and returns to previous screen.

3-2. Locking and Releasing of Screen

The screen can be locked to prevent unforeseeable misoperations, etc.

Touch operation of all screens is prohibited when locked (the lock icon is displayed at the top of the screen). Note however that the Memory button **5**, Measuring button **8** and Power button **10** will be operational even if lock is ON.

Lock status will be maintained even when power is turned OFF.

Setting Lock:

Press and hold down Menu button **7** for approximately 1 second to lock the screen (the lock icon will be displayed at the top right of the screen). Buttons and icons on the LCD (touch panel) cannot be operated while the lock is ON. Moreover, pressing the Menu button **7** to open the Menu Functions is not possible.

* This lock function can be set in the Measuring screen only.

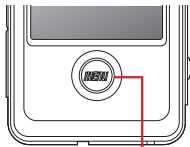

Menu button **7**



Releasing Lock:

Press and hold down the Menu button **7** for approximately 1 second to release the locked screen (the screen locked icon will disappear.)

Locked



Screen lock icon

Lock Released



3-3. Outline of Screen Flowchart

1) Measuring Screen (Background color: Black in default setting, selectable in Custom setting)

1. When the power is turned ON, the display will indicate settings last used when the meter was turned OFF.

To select another Measuring Mode, touch a Measuring mode icon () to go to Measuring Mode Selection Screen. Touch different icon to select mode and return to Measuring screen.

2. Touch the Information icon (Info icon) to display current display mode, input exposure compensation, and exposure profile in use. (See P20 for details.)
 3. When Radio Triggering mode is selected, the Power Control icon (Power Control icon) appears under the icon of . Press Power Control icon for ControlTL power adjustment and Zone selection for both Standard and ControlTL system. (See P38 for details.)
 4. To use the Average Function or Contrast Function, touch the Average/ Δ EV icon (Average/ Δ EV icon). (For details, see P49 for Average Function, and see P 50 for Contrast Function.)
- 2) Tool Box Screen (Background color: Green)
To make various settings for the current Measuring screen, touch the Tool Box icon (Tool Box icon) at the Measuring screen. (See P20 for details.)
- 3) Menu Screen (Background color: Light orange)
Press the Menu button on the meter (while working in any screen) to display the Menu screen (*1).
At the Menu screen, you can set all menu operations for this light meter. (See P21 for details.)

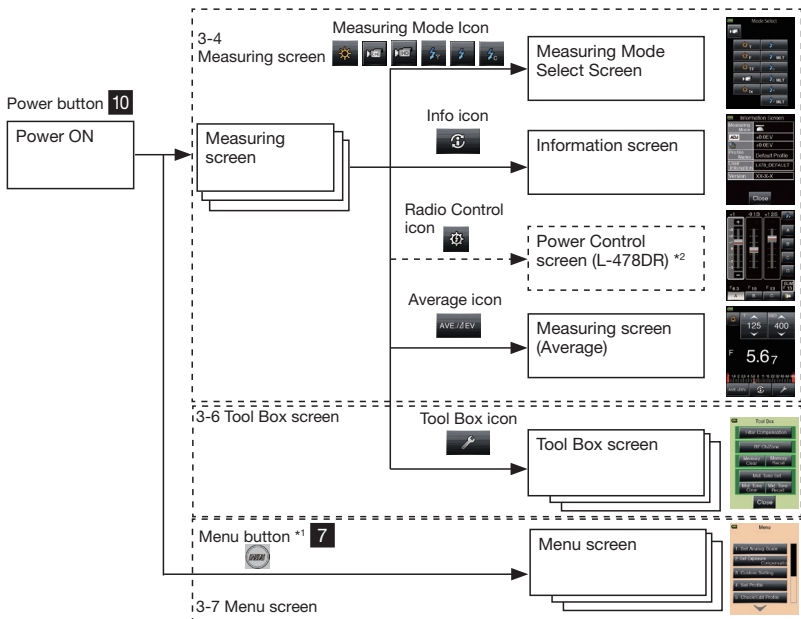

*1 If you press the Menu button while working at another Setting screen, the settings in mid-operation will be interrupted and the Menu List displayed.

*2 This screen is displayed only when the Radio Triggering mode is being used (for L-478DR only).

4) Hardware Setting Screen

Hold down the Menu button (7) and then turn ON the power to display the Hardware Setting screen. (See P62 for details.)

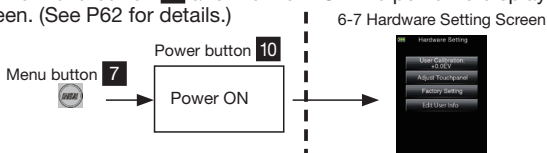

3-4. Measuring Screen

When the power is turned ON, the Title screen will appear, followed by the Measuring screen.

Subject measuring can be performed at the Measuring screen.

Basic Configuration of the Measuring Screen

Example of T priority in Ambient Light Screen

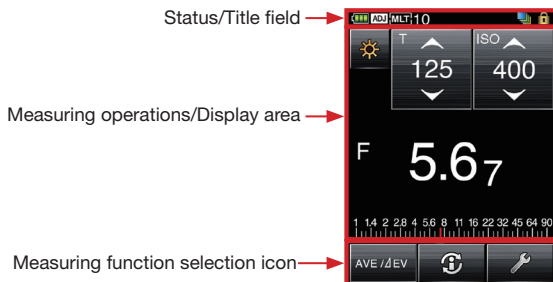

3-4-1. Status/Title Field

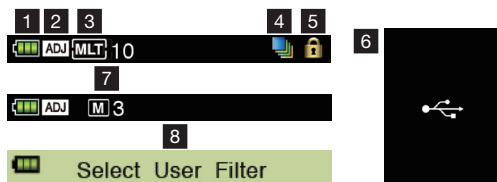

No.	Icon Name	Explanation
1	Battery Power Indicator Display	Battery power display in four stages. (See P11 for details.)
2	Exposure compensation	Displayed when Exposure compensation (adjustment) is set. The displayed measured value is calculated with this compensation value.
3	Multiple (Cumulative) Flash mode/ Cumulative count	Displayed when Accumulative Mode is selected for the following flash measuring modes. <ul style="list-style-type: none"> ● Cordless Multiple (cumulative) Flash mode ● Cord (PC) Multiple (cumulative) Flash mode ● Radio Multiple (cumulative) Flash mode (for L-478DR only) Cumulative count (up to 99) is displayed to the right of the MLT symbol.
4	Filter compensation	Displayed when filter compensation is selected.
5	Screen lock	Displayed when screen Lock is active. Touch screen is not active when displayed. (See P14 for details.)
6	USB display	Displayed when meter is connected to a computer by USB cable.
7	Memory count	Displays up to 9 memorized readings.
8	Title	Appears to indicate which setting mode is active.

3-4-2. Setting, Function, Display Field

Setting, Function, and Display Field are configured of the following sections.

- Measuring mode icons
- Setting icons
- Measuring unit/Displayed value field
- Analog scale

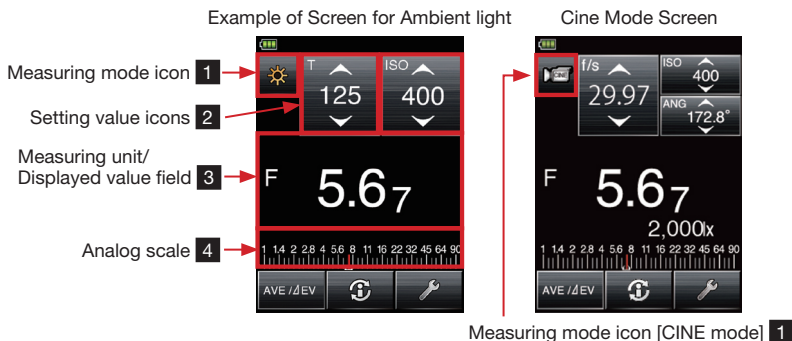

1) Measuring Mode Icons

Touch a Measuring mode icon (☀️, 📷, 🎥, 📹, 📺, 📻) at the top left of the Measuring screen to display the Measuring Mode Selection screen, where any of the Measuring modes can be selected. (See P25 for details.)

2) Setting Icons

Setting icons type and value will change with the Measuring mode in use. Touch or slide finger up/down over the icons to change the value.

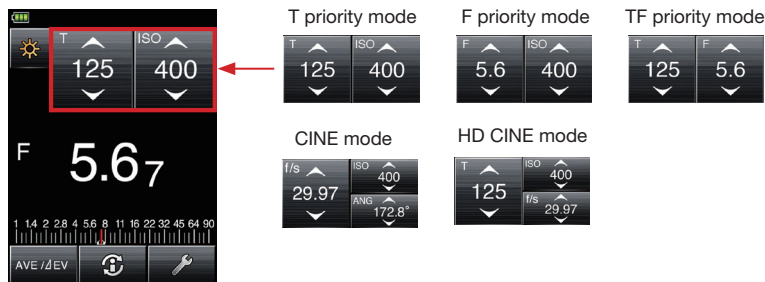

Explanation of value types

- T : Shutter speed
Shutter speed is displayed in the following way.
30m (30 minutes), 8s (8 seconds), 125 (1/125 of a second)
- ISO : ISO sensitivity
- F : f-stop (aperture)
- ANG : Shutter angle
- f/s : Frames per second (Cine frame rate)

Operating Set Icon:

Value increases when up arrow (▲) is touched.

Value decreases when down arrow (▼) is touched.

Slide the icon number up or down with your fingertip to increase or decrease the reading.



3) Measuring unit/Displayed value field

This displays information such as measured values and measuring units.

Measuring value unit: T (shutter speed), F (f-stop), ISO (ISO sensitivity)

Measuring values

Additional info for measuring value
Example: 1,900,000lx

Measuring mode information display

- lx.: Ambient light illuminance lx independent display
- fc: Ambient light illuminance fc independent display
- cd/m²: Ambient light luminance cd/m² independent display
- fl: Ambient light luminance fl independent display

Measuring value unit: F (f-stop)

Flash component

•The ratio of flash light to the total exposure is displayed as a percentage (in 10% steps)

← Measuring value

Reference

The fractions of the measuring values can be hidden by changing setting at the Custom Setting Function. Display setting number 2 (fraction display) and then select 0 (ON) to display fraction and 1 (OFF) to hide fraction. (See P55 for details.)

Fraction hidden

T 0.4s T 1.3m

Fraction displayed

T 0.4s₂ T 1.3m₁

4) Analog Scale

Depending on the Measuring mode, the following values will be displayed in the scale.

- F value, T value, EV value (for incident), EV value (for reflected), illuminance lx (lux), illuminance fc

The following is a scale display example.

Analog Scale Display (F value) Example

[Example of analog scale when Mid.Tone is NOT set]



Memory pointers

Measured value pointer

[Example of analog scale when Mid.Tone is set]



Dynamic range [-] Dynamic range [+]
Clipping point [-] Clipping point [+]
Memory pointers

Measuring value pointer

3-4-3. Measuring Function Selection Icon

Press any one of the icons to execute that function.

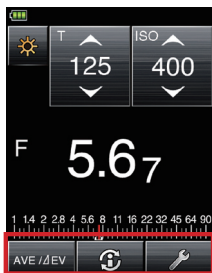

1

2

3

No.	Icon	Explanation
1	AVE/ΔEV icon	Touch to average one or more memorized measurements (see 6-3 P49) or to activate Contrast Function (6-4 P50).
2	Information icon	Touch to display Measuring mode and meter in formation (see 3-5 P20 for details)
3	Tool Box icon	Touch to display Tool Box screen to set various functions. (see 3-6 P20 for details)

3-5. Information Screen

Displays setting details of measuring screen icons and meter information

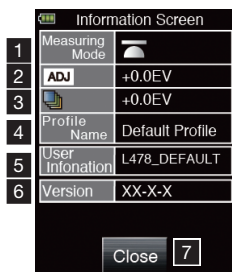

No.	Item	Explanation
1	Light receiving method	Displays incident light (☀ or ☾) /reflected light (◀) selection.
2	Exposure compensation (adjustment)	User-set exposure compensation value (see P53 for details)
3	Filter compensation	User-set filter compensation value (see P51 for details)
4	Exposure profile name	Name of exposure profile in use (See P56 for details)
5	User information	Set user information in "Edit User Info" of Hardware Setting is displayed (See P62 for details).
6	Version	Meter firmware version in use.
7	Close	Returns to Measuring screen.

3-6. Tool Box Screen

The following settings can be made by selecting the Tool Box from the Measuring screen.

- Filter compensation setting
- Memory recall, memory clear
- Mid tone set, mid tone clear, mid tone recall
- Radio trigger channel setting (for L-478DR only)

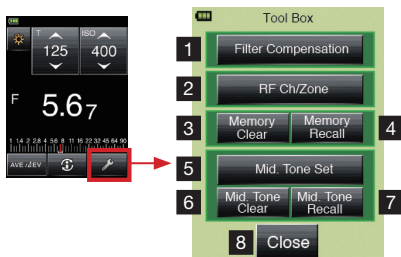

No.	Item	Explanation
1	Filter compensation	Displays Filter compensation setting screen. (See P51 for details.)
2	Radio trigger channel (for L-478DR only)	Displays Radio Trigger Channel Setting screen. (See P38 for details.)
3	Memory clear	Displays Memory Clear screen. (See P45 for details.)
4	Memory recall	Displays Memory Recall Selection screen. (See P44 for details.)
5	Mid tone set	Displays Mid. Tone Set screen (See P46 for details.)
6	Mid tone clear	Displays Mid. Tone clear screen. (See P47 for details.)
7	Mid tone recall	Displays Mid. Tone Recall screen. (See P48 for details.)
8	Close	Returns to Measuring screen.

3-7. Menu Screen

Press the Menu button **7** on the meter to display the Menu screen.

Press the Menu button **7** again to return to the previous screen.

! Note

- If the Menu button **7** is pressed while entering or editing settings in another screen, the settings will be lost and the Menu screen will be displayed.

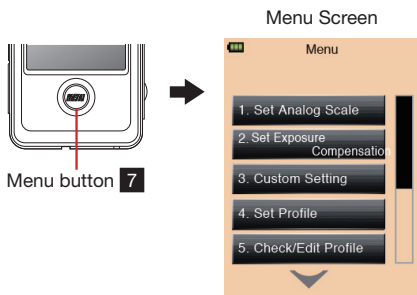

Menu Items

No.	Item	Explanation
1	Set Analog Scale	Select Analog Scale type for use (See P53 for details.)
2	Set Exposure Compensation	Input Exposure Compensation values for use. (See P53 for details.)
3	Custom Setting	Displays list of available Custom Settings. (See P55 for details.)
4	Set Profile	Select Exposure Profile for use. (See P56 for details.)
5	Check/Editing Profile	Create, edit and select profiles for display and use (See P56 for details.)
6	Edit Frame Rate	Create and Select frame rates for display and use. (See P58 for details.)
7	Edit Shutter Angle	Create and Select shutter angles for use. (See P59 for details.)
8	Edit Filter	Select and edit filter compensation values for display and use (See P60 for details.)

4 Basic Operations

4-1. Basic Operation Flow

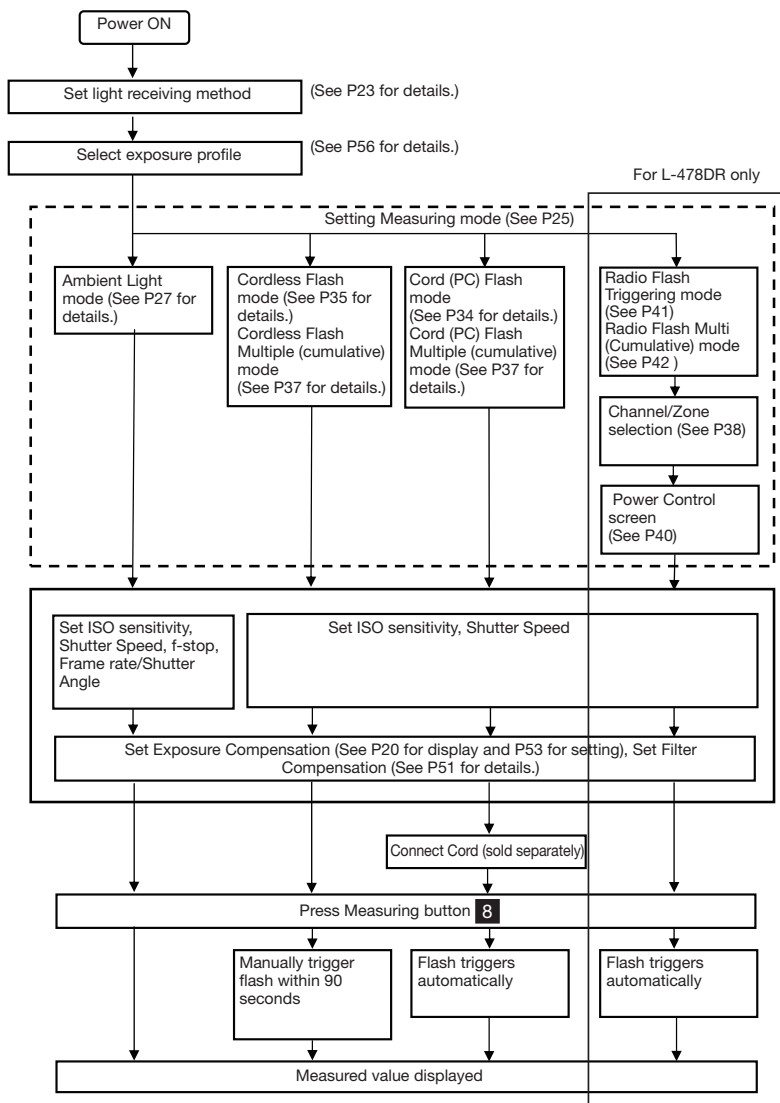

4-2. Setting Light Receiving System

4-2-1. Measuring with Incident Light Function (Lumisphere Extended /Retracted)

Use either extended or retracted (flat) lumisphere to measure incident light. Point the lumisphere at the camera (lens optical axis) from a position close to the subject and then measure.

1. Extending Lumisphere

Rotate the Lumisphere retracting ring **2** to align the mark with the extended symbol (☰) on the meter head.

2. Retracting Lumisphere

Rotate the Lumisphere retracting ring **2** to align the mark with retracted symbol (☷) on the meter head.

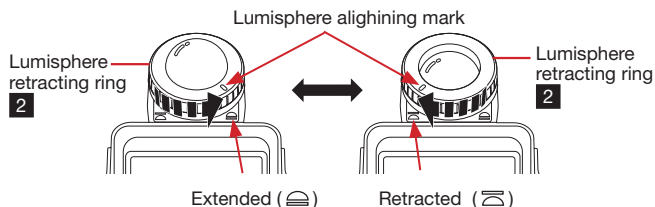
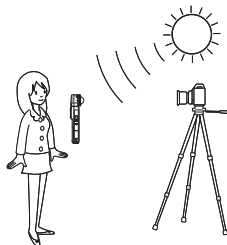

Lumisphere Extended	Lumisphere Retracted (flat)
Extend Lumisphere when measuring 3D subjects such as people, buildings, etc.	Retract lumisphere when measuring flat subjects such as manuscripts, books, pictures, green screens, or when measuring lighting ratio (Contrast function) (see P50 for details) or simply measuring intensity of illumination (see P28 for details).

! Note

- Try to minimize the influence of the person taking the light measurements. (Do not obstruct the light sources. There will also be reflected light from the person's clothing, so do not allow this reflected light to enter the light receptor.)
- If the light meter is used with the Lumisphere retracting ring in a middle position, distributed light quality will change, and suitable measurements cannot be made.
- Do not push down the lumisphere with your hand.
- Because it may affect the precision of the measurements, be careful not to damage or dirty the Lumisphere/Light receptor. When Lumisphere becomes dirty, wipe it with a dry, soft cloth. Never use organic solvent such as thinner or benzene.

4-2-2. Measuring with Reflected Light System

Use 5-degree Viewfinder, reflected light attachment, (sold separately) to make reflected light readings with the L-478D/DR. This method measures the brightness (luminance) of the light reflected from the subject. It is useful for distant objects such as landscapes, when you cannot go to the position of the subject, or for metering subjects that generate light (neon signs, etc), highly reflective surfaces or translucent subjects (stained glass, etc).

Reflected light measurements are made at the camera position by aligning the circle in the viewfinder eyepiece with the subject area to be measured.

* See operating manual included with 5-Degree Viewfinder (sold separately).

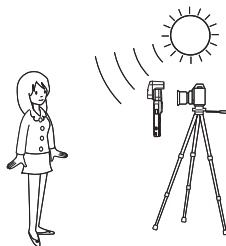

1. Remove the Lumisphere

The lumisphere unit is removed by holding both the upper and lower sections of Lumisphere retracting ring and turning it to the left while pushing the Lock lever **1** downward

2. Attach the Lumisphere

Align the mark on the Lumisphere with the mark on the meter head and, while pressing it in, turn the Lumisphere to the right until it clicks into place.

* Check to see that the Lumisphere lock lever **1** is engaged.

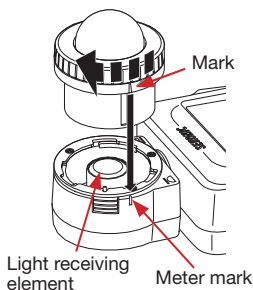
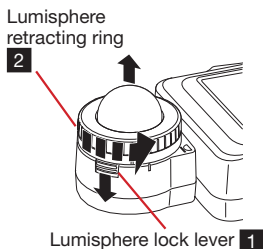

! Note

- When attaching/detaching lumisphere or viewfinder, be sure not to touch the light receiving element inside the meter head.
- When the light receiving element gets dirty, clean it with soft and dry cloth. Never use organic cleaners such as thinner or benzene.







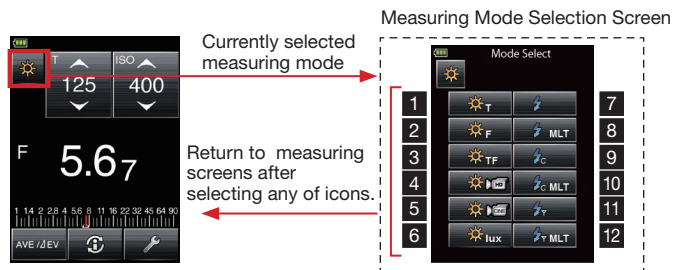





4-3. Setting Measuring Mode

Touch the Measuring mode icon  at the top left of the Measuring screen and then select any one of the Measuring modes.

* The Measuring modes displayed on the Measuring Mode Selection screen will change depending on the settings at Custom Setting. (See P55 for details.)



About Measuring Modes

Mode	No.	Icon	Explanation	
Ambient Light Mode	1		T (shutter speed) priority Displays f-stop (aperture) value for input shutter speed and ISO sensitivity. (See P27 for details.)	
	2		F (stop) priority Displays shutter speed value for input f-stop and ISO sensitivity. (See P28 for details.)	
	3		TF (shutter speed and f-stop) priority Displays ISO sensitivity value for input shutter speed and f-stop. (See P28 for details.)	
	4		HD Cine mode Displays f-stop value for input shutter speed, ISO sensitivity and frame rate (f/s). (See P32 for details.)	
	5		Cine mode Displays f-stop value for input frame rate (f/s), ISO sensitivity and shutter angle. (See P31 for details.)	
	6		lux	Illuminance Lux(lx) mode Displays brightness value in Lux(lx) unit in incident light. (See P29 for details.)
			fc	Illuminance (fc) mode Displays brightness value in foot-candle (fc) unit in incident light. (See P29 for details.)
			cd/m ²	Luminance (cd/m ²) mode (with 5-degree viewfinder sold separately) Displays brightness value in cd/m ² unit in reflected light. (See P30 for details.)
fl			Luminance (fl) mode (with 5-degree viewfinder sold separately) Displays brightness value in foot-lambert (fl) unit in reflected light. (See P30 for details.)	
Flash Light Mode	7		Cordless flash mode Detects flash brightness without meter-flash connection after measuring button pressed to arm meter for 90 seconds and flash fired separately. Displays f-stop (apertures) value for input shutter speed and ISO sensitivity. (See P35 for details.)	
	8		Cordless multiple (cumulative) flash mode Detects flash brightness without meter-flash connection after measuring button pressed to arm meter for 90 seconds and flash fired separately. Displays f-stop (apertures) value for input shutter speed and ISO sensitivity. (See P37 for details.)	
	9		Cord (PC) flash mode Detects flash brightness with PC cord meter-flash connection. Displays f-stop (apertures) value for input shutter speed and ISO sensitivity. (See P34 for details.)	
	10		Cord multiple (cumulative) flash mode Detects and accumulates flash brightness with PC cord meter-flash connection. Displays f-stop (apertures) value for input shutter speed and ISO sensitivity. (See P36 for details.)	
	11		Radio triggering mode *L-478DR only Detects flash brightness without meter-flash connection after radio transmitted trigger signal is received by PocketWizard® radio-receiver connected flash. Displays f-stop (apertures) value for input shutter speed and ISO sensitivity. (See P41 for details.)	
	12		Radio triggering multi (cumulative) flash mode *L-478DR only Detects and accumulates flash brightness without meter-flash connection after radio transmitted trigger signal is received by radio-receiver connected flash. Displays f-stop (apertures) value for input shutter speed and ISO sensitivity. (See P42 for details.)	

Reference

- Ambient Light refers to natural light (sunlight) as well as continuous light like tungsten lamps and fluorescent lamps.
- Flash refers to momentary light such as that produced by a flashlight or flash bulb.
- If all light measuring modes are turned OFF, Ambient Light T priority will be selected.

5 Measuring

5-1. Measuring in Ambient Light Mode

Continuous light like natural light (sunlight) as well as tungsten lamps and fluorescent lamps are measured in Ambient Light Mode.

The following are the measuring methods in the Ambient Light Mode.



- T (shutter speed) priority
- F (stop) priority
- TF (EV) priority
- Illuminance lux independent display
- Illuminance fc independent display
- Luminance cd/m² independent display (with reflected light attachment sold separately)
- Luminance fl independent display (with reflected light attachment sold separately)

See 4-3 “Setting Measuring Mode” (P25) for details on changing measuring mode.

Reference

- Shutter speed and f-stop (aperture) values can be displayed in full, 1/2 and 1/3 stop increments in Custom Setting (See P55 for details.)
- After taking a measurement, changing a T or F setting value will also change the measured value.
- Touching the Average/ Δ EV button (AVE/ Δ EV) at the bottom of the screen activates the Contrast Function. (See P50 for details.)
- The Analog Scale display will change according to Measuring Mode, Incident/Reflected and Mid-Tone mode selected as well as “Set Analog Scale” in Menu list (See P19 and P53 for details.)
- See P42 for details about reading outside the display range or beyond the measuring range.

5-1-1. T (Shutter Speed) Priority Mode

1. Touch the Measuring mode icon to open the Measuring Mode Selection Screen, then touch the  icon to select T Priority Mode and return the screen view to Measuring screen. (See P25 for details.)
2. Set the ISO sensitivity value on the ISO icon.
3. Set the shutter speed on the T icon.
4. Press the Measuring button  on the side of meter.



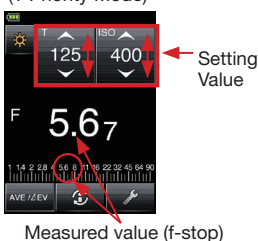

Release the Measuring button  to complete the measurement. The measured f-stop (aperture) value at that time will be displayed.

While pressing the Measuring button , the meter measures continuously until it is released.

Measuring Screen
(T Priority Mode)



5-1-2. F (f-stop) Priority Mode



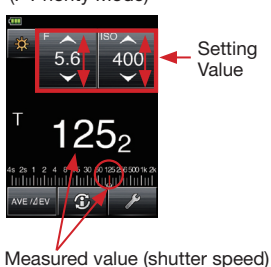

1. Touch the Measuring mode icon to open the Measuring Mode Selection Screen, then touch the  icon to select F Priority Mode and return the screen view to Measuring screen (See P25 for details.)
2. Set the ISO sensitivity value on the ISO icon.
3. Set the f-stop (aperture) value on the F icon.
4. Press the Measuring button  on the side of meter. Release the Measuring button  to complete the measurement. The measured shutter speed value at that time will be displayed. While pressing the Measuring button , the meter measures continuously until it is released.

Measuring Screen
(F Priority Mode)



5-1-3. TF Priority Mode

TF Mode is useful for today's digital cameras when a fixed speed and aperture are desired and the ISO can be adjusted for proper exposure. (See Custom Setting Function P55 to activate TF mode Icon.)

1. Touch the Measuring mode icon To open the Measuring Mode Selection, then touch the  icon to select TF Priority Mode and return the screen view to Measuring screen. (See P25 for details.)
2. Set shutter speed on the T icon.
3. Set f-stop on the F icon.
4. Press Measuring button  on the side of meter. Release the Measuring button  to complete the measurement. The measured ISO sensitivity value at that time will be displayed. While pressing the Measuring button , the meter measures continuously until it is released.

Measuring Screen
(TF Priority Mode)

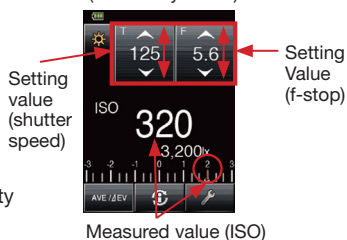

5-1-4. Illuminance/Luminance Mode

Illuminance can be measured using the incident light mode and luminance can be measured using the reflected light attachment (5-degree viewfinder sold separately). The following are the units that can be set.

Incident light measurement (Illuminance)

- Lux (Unit: lx)
- Foot-candle (Unit: fc)

Reflected light measurement (Luminance)

- Candela per square meter (Unit: cd/m²)
- Foot-lambert (Unit: fl)

Reference

- Any calibration or exposure compensation will not be in effect with illuminance/luminance measurements.

1) Illumination Measuring in Lux

1. Rotate the Lumisphere retracting ring **2** and align the mark with the ☰ symbol.
2. Touch the Measuring mode icon to open the Measuring Mode Selection Screen, then touch the  icon to select Illuminance Measuring (lux) Mode and return the screen view to Measuring screen. (See P25 for details.)
3. Position the Retracted Lumisphere so that it is parallel with the light source being measured and press the Measuring Button **8** on the side of the meter. Release the Measuring button **8** to complete the measurement. The measured illuminance (lux) at that time will be displayed. While pressing the Measuring button **8**, the meter measures continuously until it is released.

Lumisphere retracting ring **2**

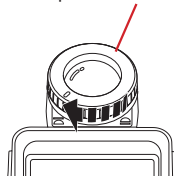

Measuring screen (lx)

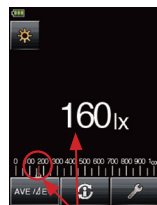

Measured value (lx)

2) Illuminance measuring in Foot-candle

1. Rotate the Lumisphere retracting ring **2** and align the ring with the ☰ symbol.
2. Touch the Measuring mode icon to open the Measuring Mode Selection Screen, then touch the  icon to select Illuminance Measuring (fc) Mode and return the screen view to Measuring screen. (See P25 for details.)
3. Position the Retracted Lumisphere so that it is parallel with the light source being measured and press the Measuring Button **8** on the side of the meter. Release the Measuring button **8** to complete the measurement. The measured illuminance (fc) at that time will be displayed. While pressing the Measuring button **8**, the meter measures continuously until it is released.

Measuring screen (fc)





Measuring value (fc)

3) Luminance measuring in Candela per square meter

1. Attach a 5-degree viewfinder (sold separately). (See P24 for details.)
2. Touch the Measuring mode icon to open the Measuring Mode Selection Screen, then touch the  icon to select Luminance Measuring (cd/m²) Mode and return the screen view to Measuring screen. (See P25 for details.)

3. While looking through the viewfinder, place the reading circle on the light source or surface to be measured and press the Measuring button  on the side of the meter.

Release the Measuring button  to complete the measurement. The measured luminance (cd/m²) at that time will be displayed.

While pressing the Measuring button , the meter measures continuously until it is released.

Measuring screen (cd/m²)





Measuring value (cd/m²)

4) Luminance measuring in Foot-lambert

1. Attach a 5-degree viewfinder (sold separately). (See P24 for details.)
2. Touch the Measuring mode icon to open the Measuring Mode Selection Screen, then touch the  icon to select Luminance Measuring (fl) Mode and return the screen view to Measuring screen. (See P25 for details.)

3. While looking through the viewfinder, place the reading circle on the light source or surface to be measured and press the Measuring button  on the side of the meter.

Release the Measuring button  to complete the measurement. The measured luminance (fl) at that time will be displayed.

While pressing the Measuring button , the meter measures continuously until it is released.

Measuring screen (fl)





Measuring value (fl)

5-1-5. Measuring Exposure for Video and Movies

1) CINE Mode

This is a measuring exposure for cine cameras

1. Touch the Measuring mode icon to open the Measuring Mode Selection Screen, then touch the  icon to select CINE Measuring Mode and return the screen view to Measuring screen. (See P25 for details.)
2. Set frame rate on f/s icon.
3. Touch the ISO icon to expand it, and set ISO sensitivity value. The ISO icon will return to its reduced size after a setting is made and the icon is not touched for a short time
4. Touch the ANG icon to expand it, and set shutter angle value. The ANG icon will return to its reduced size after a setting is made and the icon is not touched for a short time
5. Add any filter compensation value to adjust the reading to the light source or lens filtration in use. (see P51 for details)
6. Press the Measuring button  on the side of meter.

Release the Measuring button  to complete the measurement. The measured f-stop (aperture) value at that time will be displayed.

While pressing the Measuring button , the meter measures continuously until it is released.

Measuring Screen (CINE Mode)

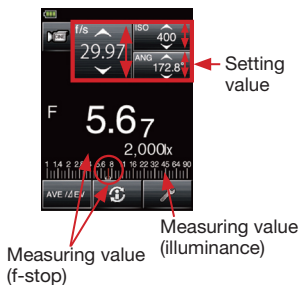



Reference

- F-stop (aperture) values can be displayed in full, 1/2 and 1/3 stop increments in Custom Setting (See P55 for details.)
- There are 20 preset of frame rates that can be set at “Edit Frame Rate” in the MENU list. (See P58 for details.)
- There are 20 preset of shutter angles that can be set at “Edit Shutter Angle” in the MENU list (See P59 for details.)
- After taking a measurement, changing frame rate value will also change the measured value (f-stop).
- After taking a measurement, changing ISO value will also change the measured value (f-stop).
- After taking a measurement, changing shutter angle will also change the measured value (f-stop).
- Touching the Average/ Δ EV button () at the bottom of the screen activates the Contrast Function. (See P50 for details.)
- The Analog Scale display will change according to Measuring Mode, Incident/Reflected and Mid-Tone mode selected as well as “Set Analog Scale” in Menu list (See P19 and P53 for details.)
- See P42 for details about reading outside the display range or beyond the measuring range

2) HD CINE mode

This is a measuring exposure for HD Video/DSLR Cameras

1. Touch the Measuring mode icon to open the Measuring Mode Selection Screen, then touch the  icon to select HD CINE Measuring Mode and return the screen view to Measuring screen. (See P25 for details.)
2. Set the shutter speed on the T icon.
3. Touch the ISO icon to expand it, and set ISO sensitivity value. The ISO icon will return to its reduced size after a setting is made and the icon is not touched for a short time.
4. Touch the f/s icon to expand it, and set frame rate value. The f/s icon will return to its reduced size after a setting is made and the icon is not touched for a short time.
5. Add any filter compensation value to adjust the reading to the light source or lens filtration in use. (see P51 for details)
6. Press the Measuring button  on the side of meter.

Release the Measuring button  to complete the measurement. The measured f-stop (aperture) value at that time will be displayed.

While pressing the Measuring button , the meter measures continuously until it is released.

Measuring Screen (HD CINE Mode)

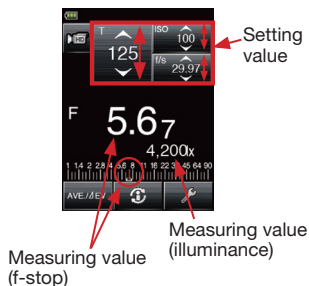

Reference

- Shutter speed and f-stop (aperture) values can be displayed in full, 1/2 and 1/3 stop increments in Custom Setting (See P55 for details.)
- There are 20 preset of frame rates that can be set at “Edit Frame Rate” in the MENU list. (See P58 for details.)
- After taking a measurement, changing a T setting value will also change the measured value (f-stop).
- After taking a measurement, changing frame rate value will also change the measured value (f-stop)
- After taking a measurement, changing ISO value will also change the measured value (f-stop).
- Touching the Average/ΔEV button () at the bottom of the screen activates the Contrast Function. (See P50 for details.)
- The Analog Scale display will change according to Measuring Mode, Incident/Reflected and Mid-Tone mode selected as well as “Set Analog Scale” in Menu list (See P19 and P53 for details.)
- See P42 for details about reading outside the display range or beyond the measuring range

5-2. Measuring in Flash Light Mode

Flash illumination is light that is produced by the very brief light pulse of an electronic flash unit or flash bulb. Flash measurement is available in the following modes:

- Cord (PC) Flash Mode (PC/synchro cord connected)
- Cordless Flash Mode
- Cord Multiple (Cumulative) Flash Mode
- Cordless Multiple (Cumulative) Flash Mode
- Radio Triggering Mode (for L-478DR only)
- Radio Triggering Multi (Cumulative) Mode (for L-478DR only)

Also see 4-3 Setting Measuring Mode (P25) for details on changing Measuring mode.

1. Screen Display Details

When flash light is measured, f-stop (Ambient brightness + Flash brightness = total exposure) is displayed on screen. The ratio of flash light to the total exposure is displayed at that time as a percentage in 10% steps. Analog scale displays the relationship of both the ambient component (orange line) and flash component (blue).

Measuring screen
(Cord (PC) Flash Mode)

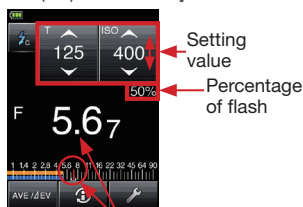

2. About the Analog Scale Details

Touch the Analog scale to toggle the ambient/flash component ratio display ON or OFF.



Measuring value (f-stop)

3. Flash Analyzing Function

When measuring Flash light, the shutter speed and f-stop (aperture) value, which is combining ambient light and flash light: total amount of light, are displayed on the LCD screen. Ambient light and flash light are each displayed as separate values along with the total amount of light on the analog scale. In addition, the ratio of flash light to the total amount of light is displayed as a percentage (in 10% steps) at the same time. The ratio of flash to the total amount of light is useful when a desired flash to ambient lighting ratio is needed.

Measuring screen
(Cordless Flash
Mode Screen)

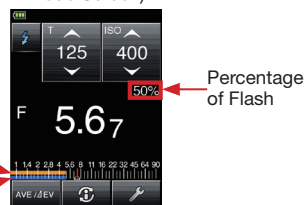

Ambient component
Flash component

<Example>

As in the screen on the right, if shutter speed is 1/125s and ISO sensitivity is 400, the flash component and tungsten lamp light will be 50% each. Likewise, the respective measuring results in the Analog Scale for flash light (blue) and Ambient Light (orange) will denote this.

Reference

- Shutter speed and f-stop (aperture) values can be displayed in full, 1/2 and 1/3 stop increments in Custom Setting (See P55 for details.)
- After taking a measurement, changing T setting value will also change the measured value (f-stop).
- After taking a measurement, changing ISO value will also change the measured value (f-stop).
- Touching the Average/ Δ EV button (AVE/ Δ EV) at the bottom of the screen activates the Contrast Function. (See P50 for details.)
- The Analog Scale display will change according to Measuring Mode, Incident/Reflected and Mid-Tone mode selected as well as “Set Analog Scale” in Menu list (See P25 and P69 for details.)
- See P42 for details about reading outside the display range or beyond the measuring range.
- The shutter speeds that can be set will vary depending on the displayed step.

5-2-1. Cord (PC) Flash Mode

In this measuring mode, a synchro cord (sold separately) is used to connect the flash to the meter. Use Cord Mode when you need to measure to total output of the flash or for measuring flash bulbs.

1. Connect the synchro cord (sold separately) to the meter's synchro terminal **13**.
2. Touch the Measuring mode icon to open the Measuring Mode Selection Screen, then touch the **$\frac{1}{2}$** icon to select Cord (PC) Flash Mode and return the screen view to Measuring screen. (See P25 for details.)
3. Set the ISO sensitivity value on the ISO icon.
4. Set shutter speed on the T (shutter speed) icon.

* Be sure the settings are within the specifications of the flash equipment.

5. Press the Measuring button **8** on the side of meter.

The flash will fire and the measured value (f-stop) will be displayed.

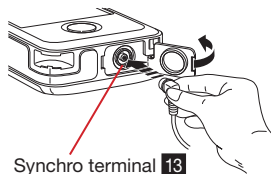

Synchro terminal **13**

Measuring screen
[Cord(PC) Flash Mode]

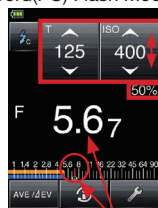

Setting values

Percentage of flash

Measuring value (f-stop)

! Note

- The electronic flash unit may trigger when the meter or flash is turned ON or when the synchro cord is plugged into the meter.
- Triggering voltage is 2.0 to 300 volts. Below 2.0V, trigger the flash with Cordless Flash Mode. (See P35 for details) or Radio Triggering Mode (See P41 for details).
- When measuring a flash bulb, be sure to check the synchronization range and set the proper shutter speed.

5-2-2. Cordless Flash Mode

In this measuring mode, Measurements are made by the meter receiving the light from the flash without synchro cord. It is used when the synchro cord will not reach because of the distance between the flash and meter, or when use of synchro cord is inconvenient.



1. Touch the Measuring mode icon to open the Measuring Mode Selection Screen. then touch the  icon displayed to select Cordless Flash Mode and return the screen view to Measuring screen. (See P25 for details.)
2. Set the ISO sensitivity value on the ISO icon.
3. Set shutter speed on the T (shutter speed) icon.





* Be sure the settings are within the specifications of the flash equipment.

4. Press the Measuring button  on the side of meter.

The meter will be put into measuring standby mode for 90 seconds and the measuring mode icon  will blink, and the illumination of LCD screen dims not to affect to the reading.

5. Trigger the flash unit manually while the Measuring mode icon  is blinking. The light will be measured and the measured value (f-stop) is displayed.

* If 90 seconds period is exceeded and the  icon stops blinking before the flash has been triggered, press the Measuring button  again to return to ready to measure status.

6. Even after measurement, the  icon continues blinking and the meter is in ready to measure status.
7. To release (cancel) the measuring standby status while the icon  is blinking for 90 seconds, touch the screen, or press either the Memory button  or Menu button .

Measuring screen (Cordless Flash Mode)

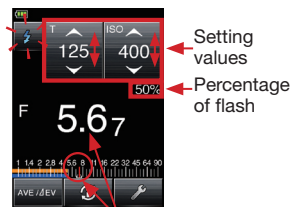

Measuring value (f-stop)

! Note

- When firing the flash, if the flash brightness is 8EV lower than the ambient light, the meter may fail to detect the light. In this case, make measurements using the Cord (PC) Flash Mode (See P34 for details).
- Rapid start fluorescent lamp and special lightings are sometimes mistaken for flash, and accidentally measured. In this case, make measurements using the Cord (PC) Flash Mode (See P34 for details)
- The waveform of a flash bulb has a slight slope and there is a possibility that the light meter cannot recognize the flashbulb in Cordless Flash Mode. In this case, make measurements using the Cord (PC) Flash Mode (See P34 for details)

Reference

- Right after measurement, the LCD screen is illuminated for 3 seconds, and then dims again not to affect the reading.

5-2-3. Cord Multi (Cumulative) Flash Mode

This Measuring mode is used when the light generated by the flash is inadequate for proper exposure. Use a synchro cord (sold separately) and connect the flash to the meter to fire the flash. The repeated flash pops can be accumulated until the desired aperture is displayed.

The cumulative count is up to 99 times, and displayed in the Test/Title field on the LCD screen. To activate this multi (cumulative) mode, set Cord Multiple (Cumulative) Flash mode ON in the Custom Setting (See P55 for details).

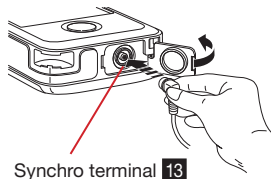

1. Connect the synchro cord (sold separately) to the synchro terminal 13 of the meter.
2. Touch the Measuring mode icon to open the Measuring Mode Selection Screen, then touch the  icon to select Cord Multiple (Cumulative) Flash Mode and return the screen view to Measuring screen. (See P25 for details.)
3. Set ISO sensitivity value on ISO icon.
4. Set shutter speed on T (shutter speed) icon.

5. Press the Measuring button  on the side of meter.

The flash will fire and the measured value (f-stop) will be displayed.

6. Repeat this operation (pressing the Measuring button  on the side of meter) only for the number of times necessary. The accumulated measured value (f-stop) and the number of cumulative flashes are displayed.

Measuring screen (Cord Multi Flash Mode)

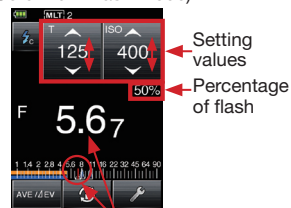

Measuring value (f-stop)

! Note

- The electronic flash unit may trigger when the meter or flash is turned ON or when the synchro cord is plugged into the meter.
- Triggering voltage is 2.0 to 300 volts. Below 2.0V, trigger the flash with Cordless Flash Mode. (See P35 for details) or Radio Triggering Mode (See P41 for details).
- When measuring a flash bulb, be sure to check the synchronization range and set the proper shutter speed.

5-2-4. Cordless Multiple (Cumulative) Flash Mode

This Measuring mode is used when the light generated by the flash is inadequate for proper exposure. The repeated flash pops can be accumulated until the desired aperture is displayed.

The cumulative count is up to 99 times, and displayed in the Test/Title field on the LCD screen.

To activate this multi (cumulative) mode, set Cord Multiple (Cumu.) Flash mode ON in the Custom Setting (See P55 for details).

In this measuring mode, the meter is set to measuring standby status (90 seconds) by pressing the Measuring button **8** on the side of meter, and during this standby time fire the flash to take measurements. The measured value (f-stop) is displayed for each trigger of the flash.

1. Touch the Measuring mode icon to open the Measuring Mode Selection Screen, then touch the **MLT** icon to select Cordless Multiple (Cumulative) Flash Mode and return the screen view to Measuring screen. (See P25 for details.)
2. Set the ISO sensitivity value on the ISO icon.
3. Set the shutter speed on the T (shutter speed) icon.
* Be sure the settings are within the specifications of the flash equipment.
4. Press the Measuring button **8** on the side of meter.
The meter will be put into measuring standby mode for 90 seconds and the measuring mode icon **8** will blink, and the illumination of LCD screen dims not to affect to the reading.
5. Trigger the flash unit manually while the Measuring mode icon **8** is blinking.
The light will be measured and the measured value (f-stop) is displayed.
* If 90 seconds period is exceeded and the **8** icon stops blinking before the flash has been triggered, press the Measuring button **8** again to return to ready to measure status.
6. Even after measurement, the **8** icon continues blinking and the meter is in ready to measure status.
7. Repeat this operation (pressing the Measuring button **8** on the side of meter) only for the number of times necessary.
The accumulated measured value (f-stop) and the number of cumulative flashes are displayed.
8. To release (cancel) the measuring standby status while the icon **8** is blinking for 90 seconds, touch the screen, or press either the Memory button **5** or Menu button **7**.

Measuring screen
(Cordless multi
flash mode)

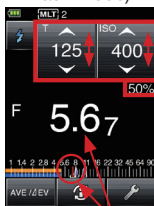

Setting values
Percentage of flash

Measuring value (f-stop)

5-3. Measuring with Radio-controlled Flash (for L-478DR only)

5-3-1. How to Measure Using Radio Control

Triggering flashes by radio requires connecting a PocketWizard® radio receiver (sold separately) to the flash unit to receive the trigger signal transmitted by the meter. Radio triggering enables a single photographer to easily trigger and measure flash.

The followings are the modes that can be set to measure this way.

- Radio Triggering Flash Mode
- Radio Triggering Multiple (Cumulative) Flash Mode

* The radio transmitter built into the L-478DR is compatible with PocketWizard® brand radio products as well as flash brands that have PocketWizard® radio receivers built into them. Please read the instruction manuals provided with these products for details about using them.

Please go to www.pocketwizard.com to learn more about radio triggering compatibility.

Note

- Successful radio triggering depends on several factors. Please read these setup steps before using the L-478DR to radio trigger flash units.
 1. It is best to position the meter in sight of the radio receiver.
 2. Position the radio receiver so that it is away from large metallic objects, concrete, or containers of water (like people).
 3. Secure the radio receiver to the flash using hook-and-loop-type attachment tape or the threaded socket on the radio. Make sure the radio's antenna is above the flash body or generator pack. Do not allow the receiver antenna to contact metal objects.
 4. Sometimes, conditions will not allow radio reception. These could include strong local radio interference, or being near objects that blocking or absorb the signal. Repositioning the radio, even slightly, can reestablish contact. Alternatively, check to see if the radio receiver is behind an object that absorbs or blocks radio waves, such as concrete, metal or low hill.
 5. Operation is best when the meter to receiver distance is within 30 meters.

5-3-2. How to Measure with Radio Control Channels

1) Radio System

The L-478DR can transmit both Standard and ControlTL® radio signals.

<ControlTL® Channel>

When used with ControlTL® receivers, the L-478DR is capable of controlling the power level of the compatible flashes connected.

The ControlTL® system features 20 channels for FCC&IC version or 3 channels for CE version, and three zones (A, B, C) allowing control of three separate flashes on each channel.

<Standard Channel>

PocketWizard® Standard radios provide simple triggering and do not allow power control. The feature 32 channels: Channels 1-16 fire single trigger signals; Channels 17-32 have four zones (A, B, C, D) which enable triggering four separate flashes on each channel.

2) Setting ControlTL® Channels and Zones

1. Touch the Tool Box icon  at the bottom of the Measuring screen to display the Tool Box screen. Then touch the **[Radio CH/Zone]** to display the Radio CH/Zone Setting screen.

Measuring screen
(Radio triggering Mode)



Tool Box
icon

2. Touch the CTL tab.
3. Either touch the arrows ▲/▼ or slide the channel number dial to select a channel.
4. Set one or more zones (A, B, C).
5. Touch the **[OK]** to confirm settings and then return to the Measuring screen. (Touch the **[Cancel]** to cancel settings)

Tool Box Screen

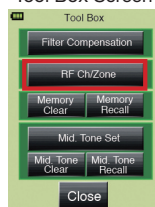

Radio CH/Zone Setting Screen (When ControlTL® system is selected)

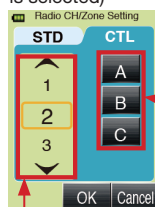

Zones

Channel numbers

3) Setting Standard Channels and Zones

1. Touch the Tool Box icon  at the bottom of the Measuring screen to display the Tool Box screen. Then touch the **[Radio CH/Zone]** to display the Radio CH/Zone Setting screen.
2. Touch the STD tab.
3. Either touch the arrows ▲/▼ or slide the channel number dial to select channel number from 1 to 32.
4. When the channel number is set to 17 – 32, Zones (A, B, C, D) will appear to select (No Zones for channels 1 to 16)
5. Touch the **[OK]** to confirm settings and return to the Measuring screen. (Touch **[Cancel]** to cancel settings.)

Radio CH/Zone Setting Screen (When Standard Channel is selected)

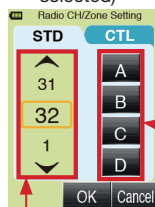

Zones

Channel numbers



Reference

- The **[OK]** button must be touched to activate the ControlTL® and Standard Channel and Zone settings.
- Zone selection can be set in Power Control Screen (See P.40)



5-3-3. Using the Power Control Settings

Select Radio Triggering Mode and ControlTL® under Radio System Preference within Custom Setting to use the Power Control Function.

* Be sure to set the T (shutter speed) and ISO sensitivity values desired in the Measuring screen before adjusting power levels and metering the controlled flash intensity.

1. Touch the Measuring mode icon to open the Measuring Mode Selection screen, then touch the  icon to activate Radio Triggering Mode and return the screen view to the Measuring screen (See P25 for details.)
2. Touch the Power Control icon  1 to display the Power Control screen.
3. Adjust flash intensity for ControlTL®.

* Please set the ControlTL® and Standard channels in advance. (See P39 for details.)

- Touch the ControlTL® Zone buttons at the bottom to select A, B, C 6.
 - The Power Bar 4 and values 3 will be activated as each Zone (A,B,C) is selected. The current level appears at the top of the bar.
 - Touch the +/- icons or slide finger up/down on the slider to set values.
 - Repeat a to c above to select other zones and set values.
 - Pressing the Measuring button on the side of meter will display the F value (f-stop) for each zone 5 as measured value for the set T (shutter speed) and ISO sensitivity value.
 - The total F value (f-stop) for selected zones will be displayed in item 8.
 - Touch the  7 modeling lamp icon to turn ON or OFF studio flash modeling lamps.  is ON, and  is OFF.
 - Touch the Radio Triggering Mode icon 9 to return to the Measuring screen.
- In this screen, Zones of Standard CH can be turned ON or OFF 2 for the Channel from 17 to 32. If the standard CH is set to 1 to 16, receivers are set to ON or OFF toggle the [CL] icon 2.
 - Be sure the Channels and Zones are the same for meter and the radio receivers in use.

Measuring Screen
(Radio Trigger mode)

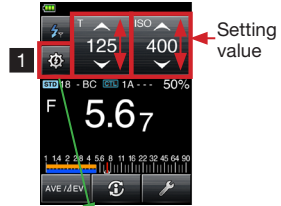

Power Control Screen
(ControlTL® +
Standard 17~32 Channels)

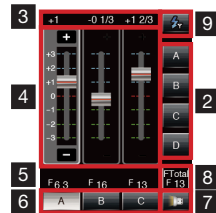

Power Control Screen
(ControlTL® +
Standard 1~16 Channels)

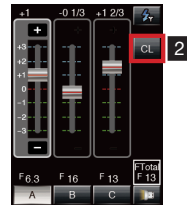

Standard channel &
zone display



Measuring value (f-stop)

Note



- The working distance of the radio triggering system can vary with the orientation and location of the meter and receivers. Be sure to carefully set them within their specifications.
- Deselected zones are displayed as "--". Also, when [CL] (Standard CH) is set to OFF, "--" is shown at STD indicator (Standard channel & zone display area) in Measuring Screen.

Reference

- The last selected zones in either Power Control Screen or Radio CH/Zone Setting Screen in ToolBox are activated in Measuring Screen.

5-3-4. Measuring in Radio Flash Mode

Select Radio Triggering Mode within Custom Setting. (See P55 for details.)

- Touch the Measuring mode icon to open the Measuring Mode Selection screen, then touch the  icon to select Radio Triggering Mode and return the screen view to Measuring screen. (See P25 for details.)
- Set the ISO sensitivity value on the ISO icon.
- Set the shutter speed on the T (shutter speed) icon.
* Be sure the settings are within the specifications of the flash equipment.
- To adjust flash intensity, touch the Power Control icon  and make adjustments as described in 5-3-3.
- Be sure the Channels and Zones are the same for meter and the radio receivers in use.
- Press the Measuring button  on the side of meter to radio trigger the flashes and display the measured exposure value (f-stop).

Measuring Screen
(Radio triggering mode)

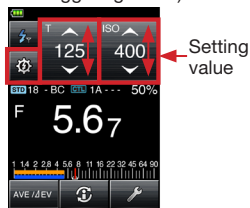



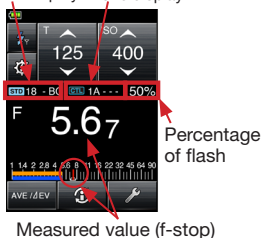

Standard channel & zone display ControlTL® channel & zone display



5-3-5. Measuring in Radio Triggering Multiple (Cumulative) Flash Mode

Select Radio Triggering Multiple (Cumulative) Mode within Custom Setting (See P55 for details.)

1. Touch the Measuring mode icon to open the Measuring Mode Selection screen, then touch the  icon to select Radio Triggering Multiple (Cumulative) Mode and return the screen view to Measuring screen. (See P25 for details.)
2. Set the ISO sensitivity value on the ISO icon.
3. Set the shutter speed on the T (shutter speed) icon.
 - * Be sure the settings are within the specifications of the flash equipment.
4. To adjust flash intensity, touch the Power Control icon  and make adjustments as described in 5-3-3.
5. Be sure the Channels and Zones are the same for meter and the radio receivers in use.
6. Press the Measuring button  on the side of meter to radio trigger the flashes and display the measured exposure value (f-stop).
7. Repeat this operation (pressing the Measuring button  on the side of meter) only for the number of times necessary. The accumulated measured value (f-stop) and the number of cumulative flashes are displayed.

[Measuring Screen]

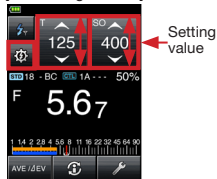

Standard channel & zone display ControlTL® channel & zone display

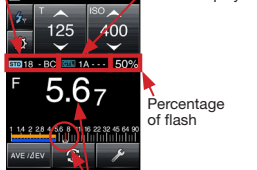

Measuring value (f-stop)

5-4. Out of Displayed Range or Measuring Range

(*This example explains what needs to be done in Cord (PC) Flash mode.)

5-4-1. When Displayed Range is Exceeded

For any given shutter speed and ISO setting, "Over" will be displayed when the measured light value requires an f-stop setting that is greater than the maximum available f-stop (f/128). "Under" will be displayed when low light requires a setting lower than the minimum f-stop (f/0.5).

Example of Over Exposure Display

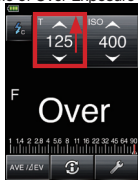

Example of Under Exposure Display

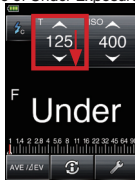

- 1) When over exposure "Over" is displayed:
When the display range is exceeded and "Over" appears, make one of the following adjustments until a suitable f-stop appears on the measuring display.
 - Change the T (shutter speed) to a faster setting.
 - Set the ISO sensitivity to lower setting.
 - If possible, lower the output power of light source, and take another measurement.
- 2) When under exposure "Under" is displayed:
When the display range is exceeded and "Under" appears, make one of the following adjustments until a suitable f-stop appears on the measuring display.
 - Change the T (shutter speed) to a lower setting.
 - Set the ISO sensitivity to higher setting.
 - If possible, raise the output power of light source, and take another measurement.

5-4-2. When Measuring Range is Exceeded

When the amount of light is outside the measuring range of the meter, the "Over" and "Under" displays will appear and blink. When this happens, adjust the brightness level to obtain a measurement.

When brightness exceeds measuring range



When brightness is under the measuring range



6 Functions

6-1. Memory Function

This meter can store up to nine measured values in memory for incident light and reflected light simultaneously. This function can be used in all modes except Illuminance/Luminance measuring and Multiple (cumulative) Flash modes.

6-1-1. Memory

1. Press the Measuring button **8** on the side of meter to take a measurement and display a value on the measuring screen.
2. Press the Memory button **5** to memorize measured value. An M 1 will appear at the top of the screen to indicate one value has been memorized and an indicator will appear on the analog scale.
3. Repeat steps 1 and 2 as desired to memorize up to 9 values for comparison.

Example of T priority in Ambient light

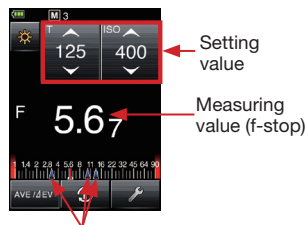



Memorized measuring values (f-stop)

! Note

- Memory Function cannot be used with the following modes.
 - Illuminance Measuring Mode (lux, fc)
 - Luminance Measuring Mode (cd/m², fl)
 - Cord Flash Accumulative Mode
 - Cordless Flash Accumulative Mode
 - Radio Flash Accumulative Mode (for L-478DR only)
- The tenth or more measurement will be displayed but can not be memorized.

6-1-2. Memory Recall

Memorized measurements can be recalled to view each value in detail. The memorized measurements appear in the order they were recorded and incident light  or reflected light  icons indicate the type of reading made. An analog scale also displays each reading in relationship.

1. Touch the Tool Box icon  at the bottom of the Measuring screen.
2. Touch the **[Memory Recall]** on the Tool Box screen to view the Memory Recall screen.
3. Measurements will appear, numbered in the order they were made. Touching one of the numbered values will display a Green Measuring Recall screen that indicates all settings made for that measurement.
4. Touching the Memory Recall button at the bottom of the screen will return to the Memory Recall screen with all memorized readings displayed.
5. Touching the Close button on any screen will return the display to the Measuring screen.

Tool Box Screen

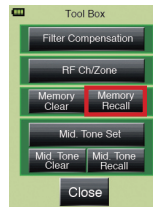

Memory Recall Selection Screen



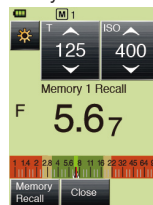

Memory Recall Screen



6-1-3. Memory Clear

Memorized measuring values can be cleared individually or collectively.

The memorized measurements appear in the order they were recorded and incident light  or reflected light  icons indicate the type of reading made. An analog scale also displays each reading in relationship.

1. Touch the Tool Box icon  at the bottom of the Measuring screen.
2. Touch the **[Memory Clear]** on the Tool Box screen to view the Memory Clear screen.
3. Measurements will appear, numbered in the order they were made. Touch the measurements you want to clear to see it highlighted. Touch the **[Clear]** at the bottom of the screen to begin clearing the reading. A Selected Memory Clear Confirmation screen will appear. Press the **[OK]** to clear the value and return to the Memory Clear screen.
4. Repeat steps 2. and 3. above to clear other memorized measurements as desired.

Reference

- Touch the **[ALL]** in step 3) above to begin clearing all readings. A Selected Memory Clear Confirmation screen will appear. Touch the OK button to clear all items and return to the Measuring screen.

5. Touch the **[Close]** to return to the Measuring screen.

Tool Box Screen

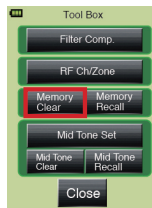

Memory Clear Screen

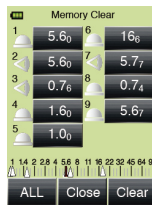

6-2. Mid. Tone Function

This is used to place a measured value at the center of the Analog EV Scale.

The Mid Tone function has four operations:

- Sets current measured value as Mid Tone
- Sets memorized value as Mid Tone
- Modifies Mid Tone value
- Recalls Mid Tone Measuring Screen

6-2-1. Setting Measuring Value as Mid. Tone

1. Press the Measuring button **8** to take reading and display the resulting value.
2. Touch the Tool Box icon  at the bottom of the Measuring screen to display the Tool Box screen.
3. Touch the **[Mid. Tone Set]** to display Mid. Tone Set screen.
4. Touch the **[Set from Current Measurement]** to set the current measured value as the Mid. Tone and return the meter to the Measuring screen.

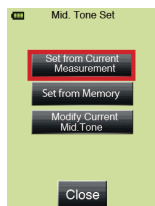

Mid. Tone Set Screen



Reference

- Touching the [CLOSE] button on any screen cancels the operation and returns the meter to the Measuring screen.

6-2-2. Setting Memorized Value as Mid. Tone

1. Touch the Tool Box icon  at the bottom of the Measuring screen to display the Tool Box screen.
2. Touch the **[Mid. Tone Set]** to display Mid. Tone Set screen.
3. Touch the **[Set from Memory]** to display Mid. Tone Set from Memory screen and display all memorized values.
 will appear next to incident light measurements;
 will appear next to reflected light measurements. The analog scale will also appear with measurement indicators displayed.
4. Touch the memorized value you want to set as a Mid Tone. The display will return to the Measuring screen and the analog scale will show all memorized values with your selection as the Mid Tone. Touch the **[CLOSE]** to return to the Measuring screen without setting the Mid. Tone.

Mid. Tone Set Screen

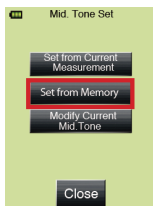

Mid. Tone Set (Memory) Screen

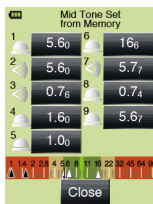

6-2-3. Mid. Tone Modification

This enables minute adjustment of the currently set Mid. Tone value.

1. Touch the Tool Box icon  at the bottom of the Measuring screen to display the Tool Box screen.
2. Touch the **[Mid. Tone Set]** to display Mid. Tone Set screen.
3. Touch the **[Modify Current Mid. Tone]** to display the Modify Mid.Tone screen.
4. Touch the arrows ▲/▼ or slide your finger over the numbers to modify the value.
5. Touch the **[OK]** to confirm the modification and return to the Measuring screen. Touch the **[Cancel]** to return to the Measuring screen without making the modification.

Mid. Tone Set Screen

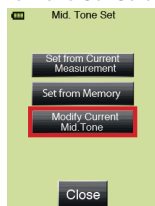

Mid. Tone Modification Screen

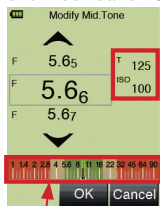

Displayed settings during measuring

Displays measuring result

6-2-4. Mid. Tone Clearing

Set Mid.Tone value can be cleared.

1. Touch the Tool Box icon  at the bottom of the Measuring screen to display the Tool Box screen.
2. Touch the **[Mid. Tone Clear]** to display the Mid.Tone Clear screen.
3. Touch the **[OK]** to clear the Mid Tone and return to the Measuring screen. Touch the **[Cancel]** to return to the Measuring screen without clearing contents.

Tool Box Screen

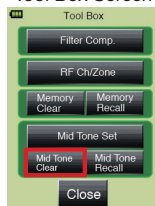

6-2-5. Mid. Tone Recall

This enables recalling the measuring screen information for the set Mid Tone.

1. Touch the Tool Box icon  at the bottom of the Measuring screen to display the Tool Box screen.
2. Touch the **[Mid. Tone Recall]** to display the measuring screen information for the Mid Tone reading.
3. Touch the **[Close]** at the bottom of the Mid. Tone Recall screen to return to the Measuring screen.

Tool Box Screen



Mid. Tone Recall Screen

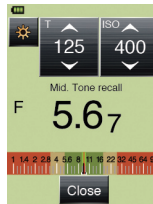

6-3. Average Function

Up to nine memorized measurements can be averaged and the result displayed. This function can be used in all modes except Illuminance/Luminance measuring and Multiple (cumulative) Flash modes.

1. Press the Measuring button **8** on the side of meter to take a measurement.
2. Press Memory button **5** to memorize the measured value. The memorized value will also appear on the analog scale.
3. Repeat steps 1. and 2. to remeasure and memorize up to nine values.
4. Touch the Average icon **AVE/DEV** at the bottom of the screen to calculate and display the result on the Digital display as well as Analog Scale. "AVE" will appear on the screen and Average icon **AVE/DEV** in reverse to indicate the Measuring screen is displaying an Averaged Value.
5. Touch the Average icon **AVE/DEV** again to return the Measuring screen value to the value last measured.

Measuring Screen
(after memory)

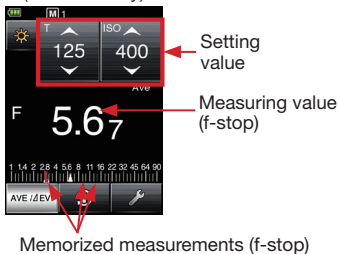

Measuring Screen
(Average)



6-4. Contrast Function

This function is useful for evaluating studio lighting, checking evenness of backgrounds such as green screens, and quick set up of lighting ratios.

After establishing a standard value, press and hold the Measuring button **8** to display the difference between the standard and new measured value. The exposure value will change to an EV value (difference in stops) change as brightness of the measured value changes. The Analog Scale will display the current measured value.

* If no values are in memory, the standard value will be the last value measured. If values are in memory, the standard value will be the average of all memorized values.

Creating Lighting ratios with Contrast Function (in Shutter Speed Priority Mode in incident light):
Retract the Lumisphere when making contrast readings.

1. Rotate the Lumisphere retracting ring **2** until fully switching to the flat position.
2. Switch ON the main light source and point the retracted lumisphere at the light source from the subject position.
3. Touch the Average/ Δ EV icon **AVE/ Δ EV** at the bottom of the screen to use the current reading (or memorized value) as "Standard Value" and display AVE on the measuring screen. The Average/ Δ EV icon **AVE/ Δ EV** will appear in reverse as long as it is the Contrast Function is active.
4. Next turn ON a second light source (fill light, hair light, etc.). Point the retracted lumisphere at the source from the subject position and press the Measuring button **8**. The display will change from exposure setting to EV value and indicate the difference in brightness between the Standard and the second value being measured. The analog scale will also display the two values. The table below shows the lighting ratio according to the difference in brightness.

Lumisphere retracting ring **2**

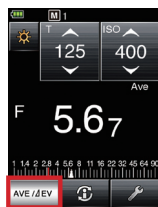
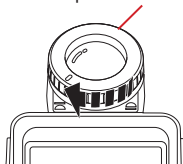

EV Difference of Measuring Value	Illumination Ratio
1	2:1
1.5	3:1
2	4:1
3	8:1
4	16:1

Example of Main Light Source Measuring

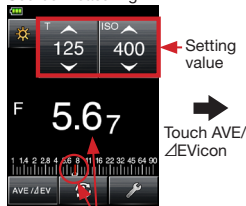

Measuring value (f-stop) using main light source



Measuring value (EV) while metering with secondary light source

Example of while contrast function is active

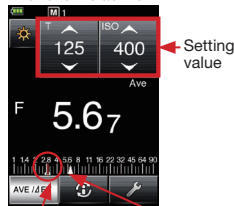

Monitored f-stop (support light source) during measuring

Memorized f-stop (main light source)

5. To return to normal measuring, touch the Average/ Δ EV icon **AVE/ Δ EV** again.

Reference

- To determine the final exposure after setting the lighting ratio, extend the lumisphere, switch ON all lights, and point the Lumisphere back towards the camera from the subject position and press the measuring button.
- The Contrast Function also can be used when measuring with reflected light.

6-5. Filter Compensation Function

The L-478's filter compensation system uses industry-standard filter naming to introduce lens and light source filtration to the meter. It also enables entering favorite filter names and values to customize meter to your shooting needs. Up to four filters can be used as a pack with the exposure display compensated for all.

A filter icon  will appear at the top of the Measuring display screen whenever a filter factor is being used.

6-5-1. Setting Filter Numbers and Compensation Values

These can be set in steps of 0.1 EV at a range of ± 5.0 EV.

1. Touch the Tool Box icon  at the bottom of the screen to open the Tool Box screen.
2. Touch the **[Filter Compensation]** to display the Filter Compensation Setting screen.
3. Touch the radio button of **[Input Filter Comp. Value]** to display the keypad on Input Filter Comp. Value.
4. Touch numbers on the keypad to input the transmission loss amount in EV (stops) (See P12 for details) and the value will appear in a box at the top of the display. Touch the **[OK]** to enter the filter factor value and return to the Filter Compensation Setting screen where the filter factor value will appear next to the Input Filter Comp Value indication.
5. Touch **[OK]** at the bottom of the screen to return to Measurement Screen to start taking readings with entered filter factor.

Reference

- In this Filter Compensation, minus factor value will cause over exposure in shooting and plus factor value will cause under exposure. Use minus compensation value for filter compensation.

Tool Box Screen

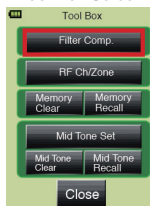

Filter Compensation Setting Screen

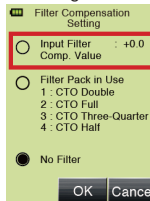

← Current filter compensation value

Filter Value Setting Screen

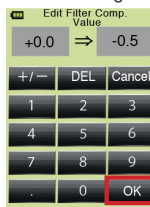

6-5-2. Selecting Filter Factor Number

Up to four filters can be used as a pack with the exposure display compensated for all. Select the necessary filter name only which will be used in the measurement.

- 1) Setting Amount of Filter Compensation
 1. Touch the Tool Box icon  at the bottom of the Measuring screen to open the Tool Box screen.
 2. Touch the **[Filter Compensation]** to display the Filter Compensation Setting screen.
 3. Touch the radio button of **[Filter pack in use]** to display the Select (Filter Pack in Use) screen. If no filters Names are present, touch one of the buttons marked 1, 2, 3, 4 to view a list of industry standard filter names.
 4. Touch a Filter Name to enter it and return to the (Filter Pack in Use) screen.
 5. If the filter you want is not immediately visible, move your finger over the Slide or touch the UP/DOWN arrows ▲/▼ to view additional filter names. Touch a Filter Name to enter it and return to the Filter Pack in Use screen.
 6. Repeat pressing a numbered button and entering a Filter Name until you have created the filter pack you want. When finished, touch the **[Close]** to return to the Filter Compensation Setting Screen.
 7. A numbered list of the filters you selected will appear on the screen. The radio button will also show that this filter selection will be in use when a measurement is made.
 8. Touch the **[OK]** to return to the Measurement Screen to start metering with the filter pack you created.

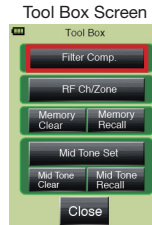

Filter Compensation Setting Screen

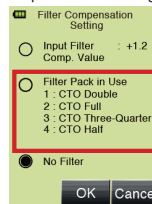

Filter factor numbers

Filter pack in use

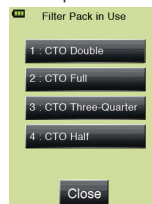

Reference

- See "8. Registered Filters (See P66)" for details about preset filters registered in the default setting, and "6-6-7. Filter Name Editing (See P60)" for details about customized preset filters.

6-5-3. Deselecting Filter

1. Touch the Tool Box icon  at the bottom of the Measuring screen to open the Tool Box screen.
2. Touch the **[Filter Compensation]** to display the Filter Compensation Setting screen.
3. Touch the radio button of **[No Filter]** in the displayed Filter Compensation Setting screen to deselect the filter in use.
4. Touch the **[OK]** to return to the Measuring screen for normal metering with no compensation.

Filter Compensation Setting Screen

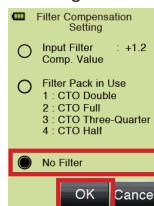

6-6. Functions by Menu Selection

6-6-1. Analog Scale Switching

The Analog Scale at the bottom of the Measuring screen graphically displays the latest measurement value, values memorized, averaged values and exposure limits (range) for exposure profile. The scale has two selectable modes: Measurement Scale and EV Scale.

1. Press the Menu button **7** on the meter. (See P21 for details.) to open the Menu screen.
2. Touch **[1. Set Analog Scale]** to display the Set Analog Scale screen.
3. Touch the **[Measurement Scale]** radio button or **[EV Scale]** radio button to select the desired scale.
4. Touch the **[OK]** to return to the Menu screen. Touch **[Cancel]** button to return to the Measuring button without selection.

Analog Scale Selection Screen
(for incident light)

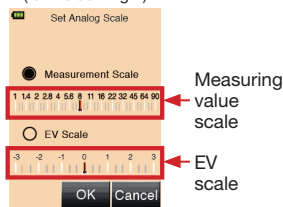

6-6-2. Exposure Compensation Function

Exposure compensation can be made in +/-9.9EV in 1/10 step increments. Exposure compensation may be necessary when compensation for highlight, shadow in reflected light, bellows, extension tube, etc is required.

When using the Exposure Compensation Function, first set the measuring mode (incident light or reflected light). Compensation can be set independently for both incident and reflected light.

Minus Compensation:

Making minus compensation will decrease the exposure (darker image).

Plus Compensation:

Making plus compensation will increase the exposure (brighter image).

Minus or plus compensation results can be opposite in the Custom Setting (See P55 for details)

1. Be sure that the Measuring method (incident or reflected light) is selected.
2. Press the Menu button **7** on the meter. (See P21 for details.) to open the Menu screen.
3. Touch the **[2. Set Exposure Compensation]** to display the keypad on the Set Exposure Compensation screen.
4. Touch numbers on the keypad to input the Exposure compensation value in EV (stops) (See P13 for details) and the value will appear in a box at the top of the display. The input range is +/-9.9EV in 1/10 step increments.

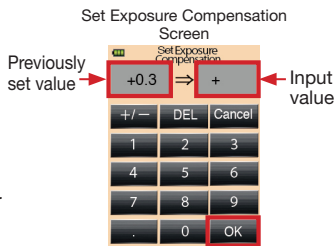

5. Touch the **[OK]** to enter the compensation amount and return to the Menu screen

Note

- Exposure compensating should be made after sufficient test shooting of the camera or film in use.

Reference

- When exposure compensation is activate, **[ADJ]** icon will be displayed on the title field in the Measuring screen to show that compensation is being performed.
- The value of exposure compensation is displayed with **[ADJ]** icon in the Information screen.
- The conventional Sekonic setting method (*1) can be selected in the Custom Setting. (See P55 for details.)
 - *1 The conventional Sekonic setting is, Plus compensation for under exposure (increase f-stop or shutter speed [= plus] achieves under exposure) and minus compensation for over exposure (decrease f-stop or shutter speed [= minus] achieves over exposure).

6-6-3. Custom Setting Function

This enables quick and easy setup of individual meter preference.

1) Custom Setting Function List

Setting No.	Custom Setting Name	Item				Default Setting
1	Increments of T+F	1 step*1	1/3 step	1/2 step	-	1 step
2	Display of 1/10 Step Increments*2	On	Off	-	-	On
3	Compensation +/- Preference	Additive Direction	Subtractive Direction	-	-	Additive Direction
4	Switching Measuring/Memory Buttons*3	Standard	Reverse	Auto-Switching*3	-	Standard
5	Ambient Mode*4,8	On	Off	-	-	On
a)	T Priority Mode*4	On	Off	-	-	On
b)	F Priority Mode*4	On	Off	-	-	On
c)	T+F Priority Mode*4	On	Off	-	-	Off
d)	HD Cine mode*4	On	Off	-	-	Off
e)	Cine mode*4	On	Off	-	-	Off
6	Flash measuring*5,8	On	Off	-	-	On
a)	Cordless mode*5	On	Off	-	-	On
b)	Cord-in mode*5	On	Off	-	-	On
c)	Radio trigger mode*5,6 (L-478DR only)	On	Off	-	-	On
c)-1	Radio System Preference*6 (for L-478DR only)	ControlTL	Standard	ControlTL + Standard	-	ControlTL + Standard
d)	Multiple (Cumulative) Flash Mode*5,7	On	Off	-	-	Off
7	Additional Data	None	EV	Luminance/ Illuminance	-	None
8	Illuminance/Luminance Unit	Lux (lx) or cd/m ²	Foot-candle (fc) or Foot-lambert (fl)	-	-	Lux (lx) or cd/m ²
9	Illuminance/Luminance Individual Display	On	Off	-	-	Off
10	Color Theme	Black	White	Rose	Blue	Black
11	Auto Power Off	5 min.	10 min.	20 min.	No auto power off	5 min
12	Backlight Brightness	Bright	Normal	Dark	-	Bright
13	Auto Dimmer	20 sec.	40 sec.	60 sec.	No dimmer	20 sec.
14	Reset Custom Setting *9	Select [OK] or [Cancel] to reset Custom Setting				

*1 1/10 step increments is always displayed in the setting of 1 step regardless of setting of "2. Display of 1/10 Step Increments".

*2 1/10 step increments ON/OFF will be effective only when 1/3 step or 1/2 step is selected.

*3 Auto switching: Measuring button **8** and Memory button **5** will be standard configuration in incident light mode, however the button configuration will be switched (in reverse) automatically in reflected light mode.

*4 When Ambient Mode is set to Off, sub settings of a) T priority Mode to e) Cine Mode cannot be selected.

*5 When Flash Mode is set to Off, sub settings of a) Cordless Mode to d) Multiple (Cumulative) Flash Mode cannot be selected.

*6 When Radio Triggering Mode is set to Off, sub setting of c)-1 Radio System Preference cannot be selected.

*7 When Multiple (Cumulative) Flash Mode is set to On, the following mode is active in the Measuring Mode Selection screen:
Cordless Multiple (Cumulative) Flash mode, Cord Multiple (Cumulative) Flash mode and Radio Triggering Multiple (Cumulative) Flash mode (for L-478DR only).

*8 When both Ambient Mode and Flash Mode are set to Off (all measuring modes are off), only T Priority Mode in Ambient Light is active.

*9 This operation returns all items set in Custom Setting to the default settings. Touch **[OK]** to return default setting or touch **[Cancel]** to cancel the reset of custom setting.

- 2) How to set Custom Setting
 1. Press the Menu button **7** on the meter (See P21 for details) to open the Menu screen.
 2. Touch “3. Custom Setting#” in the displayed Menu screen.
 3. In the displayed Custom Setting screen, either touch the arrows ▲/▼ or slide the screen with your finger to display the desired Custom Setting Name numbered and then touch it to select
 4. Touch the radio button of desired item from the options in the screen.
The • symbol appears to show the currently selected item.
 5. Touch the **[OK]** to complete the setting and return to the Custom Setting screen.
Touch the **[Cancel]** to return to the Custom Setting screen without change.
 6. Repeat steps 3) to 5) above to set other Custom Setting items.
 7. Press the Menu button **7** at the Custom Setting screen to return to the Menu screen.

Custom Setting Screen

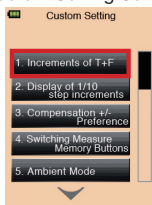

Example of Increments of T+F setting screen

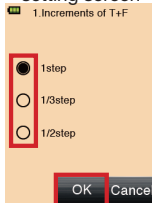

6-6-4. Exposure Profile Function

The L-478D/DR can store up to 10 camera profiles. The profiles can be created using Sekonic’s Data Transfer Software system with profile targets (sold separately) or from data obtained from other testing methods and input manually into the meter. Once input or downloaded, they can be edited, named and easily called up for use at any time.

- 1) Selecting a Camera Exposure Profile in Use in the Measuring Screen
 1. Press the Menu button **7** on the front of the meter (See P21 for details.)
 2. Touch **[4. Set Profile]** to view stored profiles.
 3. Touch ▲/▼ or slide finger on bar to view the name of the Exposure Profile you desire.
(Profiles can be added or removed from the list in the **[Check/Edit Profile]** function.)
 4. Touch the profile name to select it and return to the Measuring screen.

2) Editing Exposure Profile

1. Press the Menu button **7** on the front of the meter. (See P21 for details.)
2. Touch **[5. Check/Edit Profile]** to view profile list in the Select Profile to Edit/Check screen.
3. Touch **▲/▼** or slide finger on bar to view the name of the Exposure Profile you desire to use and edit.
4. Touch the check box **✓** to display the profile in the Set Profile screen. (A check mark **✓** indicates profile is available for use. To deactivate the profile, touch box again to return to **□**.)
5. Touch the profile name button to edit the profile.
6. To edit profile name, touch the [Edit Profile Name] to display the keypad. Input the name (up to 31 characters) and touch **[OK]** to enter the profile name and return to profile edit screen.

Edit Profile Screen

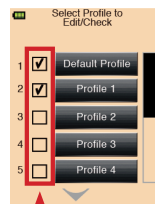

Check to display or not in the Set Profile Screen

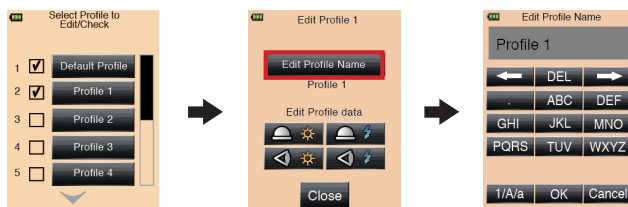

7. Touch one of the icons of Measuring mode (Ambient/flash light) and light receiving method (incident/reflected light) to enter ISO editing screen.
8. Touch **▲/▼** or slide finger on bar to view ISO values and touch the desired ISO button to enter the profile editing screen.

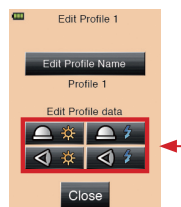

9. Input/Edit the camera /film profile characteristics.
 - a. Touch +/- buttons or move slider to set desired exposure compensation value within +/- 5 EV (stop) range.
 - b. Touch +/- buttons or move slider to desired values of dynamic ranges and clipping points for profile within +/- 10 EV (stop) range.
 - * Clipping points cannot exceed Dynamic range.
 - c. Touch **[OK]** to return to ISO selection screen. (Touch **[Cancel]** if editing is not needed. Touch **[Default]** if reset the profile of ISO being selected.)
10. Touch **[Close]** to return to Start screen for Edit profile. Create or Edit profile name if desired (See P55 for details)
11. Touch **[Close]** to return to the Select Profile to Edit/Check screen.

ISO Selection Screen

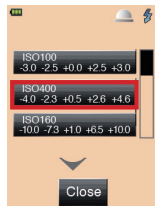

Profile Characteristic Edit Screen

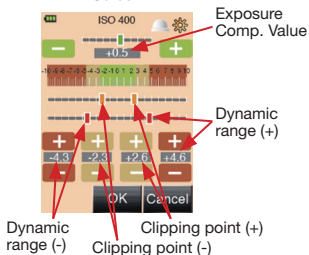

6-6-5. Frame Rate Editing

In addition to the standard frame rates available in the L-478D/DR, up to 20 frame rates can be customized and displayed in the meter screen.

* Frame rate is set in 0.001(f/s) step over a range of 0.001 to 9999.999(f/s).

1. Press the Menu button **7** on the meter. (See P21 for details.) to open the Menu screen.
2. Touch **[6. Edit Frame Rate]** to display Select Frame Rate to Edit screen.
3. Touch the check box to display the customized frame rate in the f/s setting icon in the Measuring screen for HD CINE mode and CINE mode. (A check mark indicates frame rate is available for use. To deactivate the frame rate, touch box again to return to)
4. Touch **▲/▼** or slide finger on bar to select frame rate and touch one of the frame rate button to display Input Frame Rate screen.
- 5) Touch buttons on the keypad to input the value of frame rate (See P13 for details on inputting.)

Frame rate Edit Selection Screen

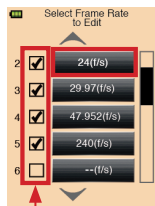

Check to display or not in the Frame Rate setting in the Measuring Screen

Input Frame rate Screen



- 6) Touch **[OK]** to return to Select Frame Rate to Edit screen. (Touch **[Cancel]** if editing is not needed.
- 7) Press the Menu button **7** to return to the Menu screen.
- 8) These customized frame rate will appear to the tail end of the selection order in the f/s setting icon in the Measuring screen for HD CINE mode and CINE mode.(From 1 to 1000 f/s are standard available frame rates, and after 1000f/s, customized frame rates appear.)

6-6-6. Shutter Angle Editing

In addition to the standard shutter angles available in the L-478D/DR, up to 20 shutter angles can customized and displayed in the meter screen.

* Shutter angle is set in 0.001° step over a range from 0.001 to 360°.

1. Press the Menu button **7** on the meter. (See P21 for details.) to open the Menu screen.
2. Touch **[7. Edit Shutter Angle]** to display Select Shutter Angle to Edit screen.
3. Touch the check box to display the customized shutter angle in the ANG setting icon in the Measuring screen. (A check mark indicates shutter angle is available for use. To deactivate the frame rate, touch box again to return to)
4. Touch **▲/▼** or slide finger on bar to select shutter angle and touch one of the shutter angle button to display Input Shutter Angle screen.
5. Touch buttons on the keypad to input the value of shutter angle (See P13 for details on inputting.)
6. Touch **[OK]** to return to Select Shutter Angle to Edit screen. (Touch **[Cancel]** if editing is not needed.
7. Press the Menu button **7** to return to the Menu screen.
8. These customized shutter angle will appear to the tail end of the selection order in the ANG setting icon in the Measuring screen for CINE mode.(From 1 to 358° are standard available shutter angles, and after 358°, customized shutter angles appear.)

Select Shutter Angle to Edit Screen

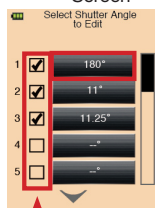

Check to display or not in the Shutter angle setting in the Measuring Screen

Input Shutter Angle Screen



6-6-7. Filter Name Editing

In addition to the standard filter name available in the L-478D/DR, up to 30 Filter Name and compensation value can be customized and displayed in the meter screen.

- * Filter compensation is set in 1/10 steps in a range of $\pm 5.0\text{EV}$.
- * See P65 for details on registered filter name and value.

1. Press the Menu button **7** on the meter to open the Menu screen. (See P21 for details.)
2. Touch the **[8. Edit Filter]** at the Menu screen.
3. Touch the check box to display the customized Filter name in the Filter pack in use (Filter compensation) in the Tool Box. (A check mark indicates the Filter name is available for use. To deactivate the Filter name, touch the box again to return to)
4. Touch the arrows **▲/▼** or slide finger on the bar to select the Filter name to display the Edit Filter screen.
5. To edit the filter name, touch the **[Edit Filter Name]** to display the keypad. Input the name (Up to 31 characters) and touch **[OK]** to enter the filter name and return to Edit Filter screen. (See P13 for details on inputting the name.)

Select Filter Name to Edit Screen

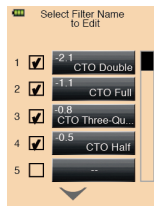

Edit Filter Screen

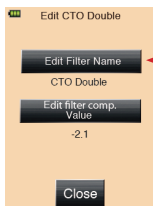

Edit Filter Name Screen



6. Touch the **[Edit Filter Comp. Value]** to display the keypad. Input the filter compensation value ($\pm 5.0\text{EV}$ in 1/10 step increments), and touch the **[OK]** to enter the filter comp. value and return to Edit Filter screen. (See P13 for details on inputting.)

Edit Filter Screen

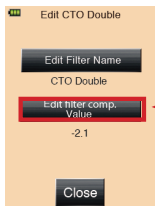

Filter compensation value button

Edit Filter Compensation Screen



7. Touch the **[Close]** to return to start screen for Select Filter Name to Edit screen. Create or Edit other Filter name and value if desired.
8. Press the Menu button  to return to the Menu screen.

Edit Filter Screen

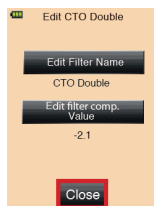

Reference

- Filter name and comp. value from 1 to 24 are preset as shown in “8. Registered Filters” on page 65. However, these 24 preset filters can be freely edited.
- For additional filter name and comp. value, use filters from 25 to 30.

6-7. Hardware Setting Function

The following settings can be made in the Hardware Setting screen.

- User calibration of measured value
- Adjust touch panel display position
- Returning to Factory settings (default settings)
- Editing user information

1) Hardware Setting Screen

1. Hold down the Menu button **7** and press the Power button **10** to enter the Hardware Setting screen.

2. Touch the desired menu item.

a. User Calibration

This meter has been calibrated to Sekonic standards. However, it provides the ability to match exposure measurements with meters to meters, correct exposure for special requirements, etc. in 1/10 step increments in a +/-1.0EV.

b. Adjust Touch Panel

This enables to adjust the position of touch panel display.

c. Factory Setting

All parameters and settings are initialized and set to factory default setting. Custom setting will be set to default setting, and customized Filter, frame rates and shutter angles will be deleted.

d. Edit User Information

Up to 31 characters can be entered to personalize the meter to distinguish from other meters, or to input contact information in case of loss.

This user information is displayed in the Information screen 

3. Press the Power button **10** to turn OFF the power.



Menu button **7**

Power button **10**

Hardware Setting Screen



- 2) User Calibration of Measured Value
 1. Touch the **[User Calibration]** in the Hardware Setting screen to display the User Calibration screen.
 2. Using the button of **[+0.1EV]** or **[-0.1EV]** at bottom of screen, adjust calibration value in 0.1 step increments.

* In this screen, it is possible to take a measurement and display the value, then adjust by using the +/-0.1EV buttons. This will be helpful if you would like to match the measured value to another meter by reading the same light source.
 3. Touch the **[Close]** to complete the setting and return to the Measuring screen.

User Calibration Screen

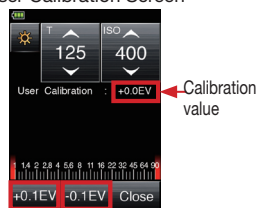

- 3) Adjust Touch Panel Display Position
 1. Touch the **[Adjust Touch Panel]** in the Hardware Setting screen to display the Touch Panel Adjusting screen.
 2. A white cross mark will appear at the upper left of the screen. Please touch this cross. A red cross mark will be displayed in the touched position.
 3. The second white cross mark will appear in another position. Touch it with finger to display a red cross mark in the touched position. Repeat this touch-and-display process eight times in total.
 4. Touch the **[OK]** in the screen saying [Data is determined by pressing the "OK".] to complete adjustments and return to Measuring screen. Touch the **[Cancel]** to cancel adjustments.

Touch Panel Adjusting Screen

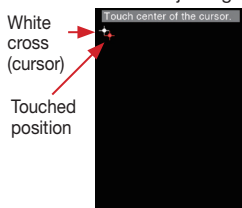

Touch Panel Adjust Confirmation Screen

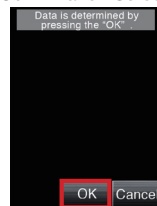

4) Factory Setting

1. Touch the **[Factory Setting]** in the Hardware Setting screen to display the Factory Setting Confirmation screen.
2. Touch the **[Yes]** to proceed factory setting (Touch the **[No]** if factory setting is not needed.)
3. Touch the **[Yes]** in the Final Confirmation screen to complete the setting and return to Measuring screen.
(Touch the **[No]** if factory setting is not needed and return to Hardware Setting screen.)

Factory Setting Confirmation Screen

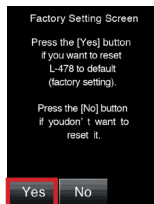

Final Confirmation Screen

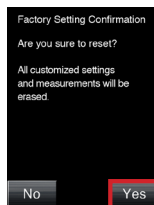

5) User Information Editing

1. Touch the **[Edit User Info]** in the Hardware Setting screen to display the keypad to input user information.
2. Currently set information (characters) appears at the top of screen. Up to 31 characters can be entered (See P13 for details.). Touch the **[OK]** to complete the input and return to the hardware Setting screen.
3. Input user information will be displayed on the Information screen.

Edit User Information Screen



7 Optional Accessories (Sold Separately)

● Synchro Cord

This is a five-meter long cord with three plugs. An exposure meter, a camera and a flash can all be connected at the same time without need to plug or unplug the cord during a shooting. Also, one of the terminals has a locking mechanism to ensure connection with a meter.

Cord has two male connectors and one female one.

The connector with the lock function is a male one.

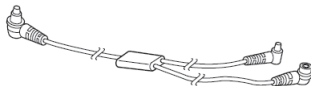

● 18% Standard Gray Card

This is a gray card (110mm x 102mm = 4.3" x 4") with 18% reflection ratio, and folds to 72mm x 125mm (=2.8" x 4.9") to fit in a shirt pocket. Use this for proper reflected light measurements of mostly bright (white) or dark (black) subjects.



● Exposure Profile Target II

Simpler to use, this is the test target (350mm x 120mm = 13.8" x 4.7") used to create camera exposure profiles. One side consists of a central 18% gray patch that is surrounded by 25 patches arranged in 1/6th stop values that are successively brighter and darker, while the other side is 18% gray card, so it can be used to determine digital camera white balancing and spot metering.

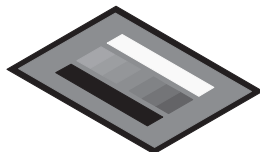

● Exposure Profile Target

This is more economical test target (260mm x 160mm = 10.2" x 6.3") used to create camera exposure profiles. One side is nine gray patches including black and white, and the other side is an 18% gray card for digital camera white balancing and spot metering.



● Viewfinder 5°

This is a viewfinder with a five degree light receiving angle for spot metering in reflected light.

It is useful for distant objects such as landscapes, when you cannot go to the position of the subject, or for metering subjects that generate light (neon signs, etc), highly reflective surfaces or translucent subjects (stained glass, etc). (See P24 for details.)

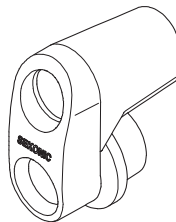

8 Registered Filters

Preset filters can be displayed in the Filter Compensation Setting. The following are the registered filters name and factor values. (See P60 for details.)

These Filter Name and Filter Factor values are preset, however, can be edited for your preferences.

No.	Filter Name	Filter Factor
1	CTO Double	-2.1
2	CTO Full	-1.1
3	CTO Three-Quarter	-0.8
4	CTO Half	-0.5
5	CTO Quarter	-0.3
6	CTO Eighth	-0.1
7	No.85	-0.8
8	CTB Double	-3.3
9	CTB Full	-1.5
10	CTB Three-Quarter	-1.3
11	CTB Half	-0.9
12	CTB Quarter	-0.4
13	CTB Eighth	-0.3
14	Minusgreen Full	-0.9
15	Minusgreen Half	-0.5
16	Minusgreen Quarter	-0.3
17	Minusgreen Eighth	-0.2
18	Plusgreen Full	-0.4
19	Plusgreen Half	-0.2
20	Plusgreen Quarter	-0.1
21	Plusgreen Eighth	-0.2
22	ND0.3	-1.0
23	ND0.6	-2.0
24	ND0.9	-3.0

9 Specifications

Type	• Digital light meter for flash and ambient light
Light Receiving Method	• Incident light and reflected light
Light Receptor	• Incident light Lumisphere convertible to flat diffuser (with retracted lumisphere) • Reflected light 5-degree spot metering with optional viewfinder
Light Receptor Element	• Silicon photo diodes
Measuring Mode	• Ambient Light Aperture priority measuring Shutter speed priority measuring TF priority measuring Cine measuring HD Cine camera measuring Illuminance measuring (lux, foot candle) Luminance measuring (foot-lambert, cdm ²) • Flash Cord Mode (with/without multiple cumulative) Cordless Mode (with/without multiple cumulative) Radio triggering Mode (with/without multiple cumulative) (for L-478DR only)
Measuring Range (ISO100)	• Ambient Light Incident light EV-2 (F2.0, 15 sec) to EV22.9 (Approx F22.9, 1/8000 sec) Reflected light EV3.0 to EV19.9 • Flash light Incident light F1.0 to F128.9 Reflected light F2.8 to F128.9 • Illuminance 0.63(EV-2.0) to 2,000,000 (EV19.6) lux 0.10 (EV-2.0) to 180,000 (EV19.6) foot candle (Reflected light) • Luminance 1.0 (EV3) to 980,000 (EV22.9) cdm ² 0.29 (EV1.5) to 290,000 (EV22.9) foot-lambert
Repeat accuracy	• ±0.1EV or less
Calibration Constant	• Incident light Lumisphere C = 340, Flat C = 250 • Reflected light K = 12.5
Display Range	• ISO ISO 3 to 409600 (in 1/3 steps) • Shutter speed Ambient Light 30 min to 1/64000 sec (in 1, 1/2 and 1/3 steps) Other possible settings: 1/200, 1/400 sec Flash light 30 min to 1/1000 sec (in 1, 1/2 and 1/3 steps) Other possible settings: 1/75, 1/80, 1/90, 1/100, 1/200, 1/400 • Aperture F0.5 to F161.2(in 1/3steps) • Frame rate (f/s) 1 to 1000, other possible settings: 20 types • Shutter angle 1° to 358° other possible settings: 20 types • EV value EV-27.9 to EV55.8 (only effective with Ambient Light) • Analog display T scale 4s to 1/2000(in 1/3 steps) F scale F1.0 to F90(in 1/3 steps) EV scale -3EV to +3EV (incident light, in 1/3 steps) -7EV to +7EV (reflected light, in 1/3 steps) Illuminance lux 0 to 50,000 lux Illuminance fc (foot candle) 0~5,000 fc Luminance cd/m ² (candela per square meter) 0~2,500 cd/m ² Luminance fl (foot-lambert) 0~1,000 fl • Contrast display -9.9EV to +9.9EV (in 1/10 steps) • Filter compensation -5.0EV to +5.0EV(in 1/10 steps) • Filter compensation selection Maximum of 4 types can be used simultaneously • Cumulative count 0 to 99 times (Maximum of 99 times is displayed) • Compensation display -9.9EV to +9.9EV (in 1/10 steps)

Other Functions	<ul style="list-style-type: none"> • Exposure Compensation • Exposure profile • Flash analyzing function • Memory function • Memory clear/recall function • Average function • Exposure out of range and display 	<p>-9.9EV to +9.9EV(in 1/10 steps) Max 10 profiles 0 to 100% (in 10% increments) 9 readings</p>
	<ul style="list-style-type: none"> • Battery power indicator display • Auto power OFF function • Liquid crystal backlight (EL) • Touch Panel lock function • Custom setting function 	<p>Under, Over warning display 4 stages Can be selected at Custom Setting ON (OFF after set time elapses)</p>
Battery	<ul style="list-style-type: none"> • Two AAA batteries (alkaline, manganese, lithium or nickel hydride) 	13 items
Radio wave frequency		
FCC&IC: (ControlTL)	CH1 ~ 4	340.0 ~ 346.0MHz
	CH5 ~ 20	341.5 ~ 351.0MHz
: (Standard)	CH1 ~ 16	344.0MHz
	CH17 ~ 32	346.5 ~ 354.0MHz
CE	CH1 ~ 3	433.42 ~ 434.42MHz
: (ControlTL)	CH1 ~ 16	433.62MHz
: (Standard)	CH17 ~ 32	434.22MHz
Operating temperature range	<ul style="list-style-type: none"> • -10°C to 50°C (no condensation) 	
Storage temperature range	<ul style="list-style-type: none"> • -20°C to 60°C (no condensation) 	
Dimensions	<ul style="list-style-type: none"> • Approx 57(W)×140(H)×26(D)mm (excluding protrusions) 	
Weight	<ul style="list-style-type: none"> • Approx 130g (L-478D without batteries), 140g (L-478DR without batteries) 	
Standard accessories	<ul style="list-style-type: none"> • Soft case, strap, Startup Guide, CD-ROM [Operating Manual (this manual) and Data Transfer Software] Anti-glare film 	

For improvement reasons the specifications in this manual and external appearance may be subject to future changes without prior notification.

10 Safety Guide and Maintenance

! Note

- To avoid damaging this meter, never drop it or subject it to shock.
- Avoid using it in water spray or rain as doing so may cause damage.
- Avoid storing it in high-temperature and/or humid locations as doing so may cause damage.
- Beware of condensation caused by sudden temperature change, as such condensation may cause damage or malfunction.
- Do not place the meter in direct sunlight during midsummer or near heaters, etc., as the temperature of the meter will rise beyond that of the air temperature. Be careful when using the meter in hot locations.

Maintenance Notes

- If your meter is splashed with water, wipe immediately with a soft dry cloth. Leaving the meter wet may cause rust or corrosion.
- Keep the light receptor head clean and free from dust/dirt and avoid scratching as accuracy may be affected.
- When light meter gets dirty, clean it with soft dry cloth. Never use organic cleaners (like thinner or benzene).
- Refer servicing only to qualified and authorized personnel in case of product's malfunction.
- Contact your local camera store or retail organization for warranty and service.

SEKONIC CORPORATION

7-24-14, Oizumi-Gakuen-Cho, Nerima-Ku, Tokyo

178-8686 Japan

Tel: +81(0)3-3978-2335 Fax: +81(0)3-3978-5229

<http://www.sekonic.com>